



NOVA[®]
The Right Solutions

World **Class**
Creativity
Is Now
in Session

DECEMBER 2015 CATALOG

Classroom Training

desks, tables, and study carrels



Collaboration

group learning and conference tables

Audio/Visual Lecterns

traditional and adjustable height

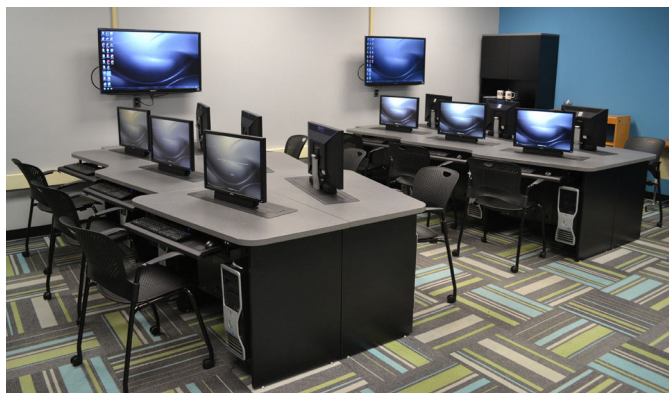

Retrofit Kits available for existing furniture and cabinetry

www.novadesk.com

Office furniture available online!



Visit www.novadesk.com for a digital catalog including:

- Desks, Credenzas, and Work Surfaces
- Hutches, Shelving and Storage Units
- Reception, Circulation Desks, and more!

*For printed office catalog requests, contact Customer Service at 800-730-6682



Contents



Classroom Training
Page 6

Audio/Visual Lecterns
Page 28

Collaboration
Page 38

Retrofit
Page 44

Accessories
Page 54

Terms & Conditions

TERMS

NOVA Solutions' (NOVA) standard terms are net 30 days with approved credit. All prices are in U.S. Dollars. Prices herein are list prices effective with the date printed on the cover and supersede all other published price lists. NOVA reserves the right to change prices without prior notice.

SELLING INFORMATION

Distribution of this price list does not in itself constitute an offer to sell. Offers can be received only from authorized NOVA dealers.

PRICES

All prices listed are suggested retail prices, F.O.B. point of shipment, freight allowed (included in list prices) when shipping within the continental United States. Orders are accepted subject to prices and taxes prevailing at the time of shipment. Prices and taxes are subject to change without notice. If shipping date requested is more than 90 days from date of order, NOVA shall have the right to use the published list prices effective at time of shipment.

ORDER PLACEMENT

NOVA requires that all orders be in writing and accompanied by a layout/drawing. This is to insure that orders are complete, avoid errors, and avoid duplication. Please order products by model numbers specified to avoid any possible error. Telephone orders will not be processed for production without proper written confirmation. NOVA cannot be held responsible for errors, omissions, and order duplication due to non-compliance with this procedure.

ORDERING INFORMATION

Mail, fax or e-mail all orders to:

NOVA Solutions, Inc.
421 W. Industrial Avenue
P.O. Box 725
Effingham, Illinois 62401
Phone: 217-342-7070
Phone: 800-730-6682
Fax: 217-342-7006
Fax: 800-940-6682
E-mail: orders@novasolutionsinc.com

For prompt delivery, all orders must include:

- 1) Purchase order number
- 2) Attached layout/drawing
- 3) Billing address
- 4) Ship-to information and e-mail address
- 5) Special handling instructions
- 6) Complete model and finish number
- 7) Correct pricing
- 8) CPU / Monitor Dimensions (Where Applicable)

ORDER ACKNOWLEDGMENT

Please notify NOVA immediately of any discrepancies in your order acknowledgement. The customer assumes all responsibility for order accuracy. NOVA does not assume responsibility for errors caused by miscommunications from the customer. Orders are accepted only by issuance of NOVA's formal acknowledgement. Orders are subject to the terms and conditions set forth herein, notwithstanding any variance in terms and conditions set forth on buyer's order forms. The order acknowledgement is the final confirmation of the agreement between the customer and NOVA and supersedes all prior oral and written statements regarding the order. Once the order confirmation has been sent, only NOVA approved and signed modifications will supersede the original confirmation.

QUOTATIONS

Quotations are valid for a period of ninety (90) days.

CHANGES

NOVA reserves the right to make changes in design, specifications, construction, pricing or to discontinue products without prior notice. Prices shown in price book have priority over electronic catalog contents. Dimensions are approximate and are within normal industry standards.

ORDER CHANGES

Upon acknowledgement of an order, NOVA may not be able to accept a change order. NOVA will not accept changes on specials or customer items once production begins. Every attempt to make the requested change will be made and the following conditions apply:

- 1) Requested changes must be submitted in writing
- 2) Additional charges for materials, labor, and administrative costs may be charged
- 3) Completion dates may be rescheduled as required based on changes

ORDER CANCELLATIONS

Order cancellations must be requested in writing no later than 48 hours after receipt of original order and are subject to approval of NOVA Solutions, Inc. Cancellations cannot be accepted otherwise.

STORAGE

Orders in which shipment is delayed by the customer beyond 30 days after acknowledged shipping date are subject to a 3% weekly storage fee. Such transfer to storage will be deemed delivery to purchaser for all purposes including invoicing and payment. Customer must provide notification of "shipment delay" at least two weeks prior to the originally scheduled ship date.

SHIPPING INFORMATION

Freight

All shipments are Free On Board (F.O.B.) point of shipment, freight prepaid and allowed (included in list prices) when shipping within the continental United States. Please contact Customer Support for shipments to Alaska, Hawaii, and international. NOVA reserves the right to select the most appropriate carrier and routing on all shipments.

NOVA's product pricing is dock delivered, based on standard delivery between normal business hours Monday through Friday, excluding weekends and holidays. Any charge arising from failure to accept a shipment, rerouting while in transit, or carrier storage charges are not included in prices shown and will be billed to "Sold To" account number on the order. Detention charges will be incurred for untimely off-loading of product or other time delays incurred.

Any orders under list pricing shown below or requiring Special Delivery Services will incur additional charges. All such requirements must be noted on the purchase order. Examples of such services include:

Handling Fee (all orders not able to be shipped via UPS): All orders under \$15,000 list will incur \$100 handling fee

Multiple site deliveries: \$75 per order and location drop charge

Non-Standard Detention Time: \$75 per hour after two hours for each delivery location
Delivery Time (outside normal delivery hours): Contact Customer Support for charges and availability

Fuel Surcharge: A fuel surcharge will be added to all items shipped via UPS, Federal Express, or other small parcel carriers.

Carriage

NOVA reserves the right to choose the best method of delivery. All furniture is carefully inspected and securely packed before shipment. The carrier will only accept packages in good condition and agrees to deliver it in the same condition. NOVA relinquishes all responsibility for goods shipped upon a signed receiving document from the carrier.

Terms & Conditions

SHIPPING INFORMATION (continued)

It is the customer's responsibility to inspect merchandise immediately upon receipt.

Loss, Damage or Delay

NOVA shall not be liable for loss, damage, or delay resulting from causes beyond its reasonable control, including but not limited to fire, strike, inclement weather, accidents, or delay in transportation. In the event of a delay, due to any such cause, the delivery date will be postponed.

Shortages

If the shipment is not delivered in accordance with the quantity of cartons and packages shown on the Bill of Lading and/or Freight Bill, do not accept it until such shortages are noted on both documents.

FREIGHT CLAIMS

The merchandise is carefully packed and thoroughly inspected before shipment. The carrier upon acceptance of the shipment assumes responsibility for its safe delivery. Claims for loss or damage sustained in transit must therefore, be made upon the carrier as follows:

Signing the Bill of Lading as "Subject to Inspection" does not make the carrier liable for damage.

Concealed Loss or Damage

Concealed loss or damage means loss or damage that does not become apparent until the merchandise has been unpacked. The contents may be damaged in transit due to rough handling even though the carton may not show external damage. When damage is discovered upon unpacking, make a written request for inspection by the carrier's agent within 7 days of the delivery date. Then file a claim with the carrier since such damage is the carrier's responsibility.

Visible Damage or Shortage

Any external evidence of damage or shortage must be noted on the freight bill or express receipts and signed by the carrier's agent. Failure to adequately describe such external evidence of damage or shortage may result in the carrier refusing to honor a damage claim. The carrier will supply the form required to file such a claim. **All cartons and packaging must be kept with the merchandise at the delivered location. Failure to do so constitutes acceptance and a waiver of any such claim.**

RETURNS

NOVA will not accept the return of any merchandise without a Returned Material Authorization (RMA). Special order items may not be returned for credit. No returns will be allowed after sixty (60) days from the ship date. If merchandise is approved for return, a restocking fee will be applied. Upon receipt, all returned merchandise will be thoroughly inspected, and any discrepancies will result in an adjustment to the amount of credit issued.

LIMITED LIFETIME WARRANTY

NOVA Solutions warrants that its products are free from defects in materials and workmanship given normal use and care for the lifetime of service; proof of delivery being the only official document accepted by NOVA for any claim. In the event that a product is used more than normal use, the applicable warranty period may be reduced.

This warranty is made by NOVA Solutions to the original customer for as long as the original customer owns and uses the product. NOVA Solutions' warranty is only valid if the products are given normal and proper use, and installed in accordance with NOVA Solutions' installation and/or application guidelines, and installed by an authorized NOVA Solutions' dealer or agent. NOVA Solutions assumes no responsibility for repairs to products sustaining damages resulting from end-user modifications, attachments to a product, misuse, abuse, alteration, or negligence.

This warranty is subject to the limitations, exclusions, and other provisions provided below:

- Twenty-five years: Thermofused laminate
- Twenty years: Drawer slides
- Ten years: Locks
- Five years: Downview technology with flat panel monitor Flat Panel Display Security Arm, high-pressure laminate, casters, fabrics, metal frame doors, electrical components, PVC extrusions, adjustable surface mechanisms, and accessories.
- Three years: The Trolley™ E and The Trolley™ EXL with Intelligent Motion Technology and NovaLinked™ Components:
 - One year for parts and repair labor; second and third year for parts only. Additional installation labor charges may not be covered by this warranty. Variation in finishes is characteristic, in terms of color & texture, and does not constitute a defect.
 - Five years: Electric Hydraulic Lift for Sit-Stand Lectern:
 - Two years for parts and repair labor; third, fourth, and fifth year for parts only. Additional installation labor charges may not be covered by this warranty. Variation in finishes is characteristic, in terms of color & texture, and does not constitute a defect.

As your manufacturer, we stand behind our quality products and will do everything possible to resolve any problems that might arise within the terms of this warranty.

For more information, or to file a warranty claim, please contact NOVA Solutions' Customer Support at 800-730-6682.

GOVERNING LAWS

This contract shall be construed and governed in accordance with the laws and regulations of the state of Illinois.

Product Benefits

Integrated Furniture Features

Extensive Product Portfolio

NOVA Solutions is proud to offer a diverse product portfolio in high-quality laminate, targeting markets that include office, education, training, hospitality, and health care. GSA and State Contracts allow government agencies to participate in NOVA's extensive offering. Architects and designers are critical contacts and liaisons for specifying "The Right Solutions™" from NOVA's unique product portfolio.

Exceptional Quality

Quality furniture shipped complete and on time is the standard of excellence required with customers to even be considered a viable offering. NOVA partners with quality suppliers that demand this same philosophy. NOVA's extensive investment in the latest state-of-the-art machining technology provides unlimited flexibility while insuring we exceed our promised fit and finish. Attention to detail at every level in the manufacturing process is a requirement. "Would I spend my money to buy that finished product?" is the final quality check.

Durable Construction

Durability and strength are necessities for the utmost value in quality furniture. Our durable thermofused laminate components provide that strength, coupled with our metal-to-metal hardware assembly. Added rigidity is integrated through framed and recessed back panels. Our first-class engineering ensures every product's design includes maximum durability and strength.

Integrated Technology

Our various Visual Display Options (The Trolley, Downview, and Surface Mount Arm for example) are unique solutions that differentiate NOVA from any other furniture manufacturer. The Trolley™ Personal Monitor Arm System with Intelligent Motion Technology™ is the latest addition to the family. The Trolley is a mainstream solution allowing you to view your flat panel display in its normal position. Then with the push of a button, your monitor recedes below the work surface allowing full utilization of the work area. Whereas our Downview technology positions your flat panel display below the work surface at a natural reading angle while also allowing you to use the entirety of the workspace in addition to the display. We also offer our Surface Mount Arm that allows you to secure your display in an upright position above the worksurface.

Quality Look

Attention to detail integrated throughout our product portfolio creates a quality look. Overlapped drawer and door designs in our office solutions products ensure the proper fit for every function. Matching edge banding on all surfaces allows a seamless view that accentuates the product's clean lines. Our Classroom Training Series gets high marks for providing a clear, crisp design that allows our Visual Display Options to blend in perfectly.

Multiple Selections

NOVA Solutions' comprehensive product portfolio confirms your only limitation is your imagination. Impress others with a vast variety of components with multiple options that fit your every need — from the back room to the boardroom. Now you can maintain a consistent company image that matches your facility and its function. Make your furniture an essential element of your productive environment!

Unlimited Flexibility

Throughout each product offering, unlimited flexibility gives you colors and shapes that can be mixed or matched to fit your style in any working or learning environment. Enjoy the freedom to create your own environment!

Customer Friendly

The majority of NOVA Solutions' furniture is shipped assembled, ready-to-install in your working or learning environment. Those components that require some assembly are designed to fit together with simplicity and minimal effort.



NOVA Solutions takes our environmental accountability seriously with regards to our daily processes and products we produce. It is our corporate responsibility to our employees, customers, and community. We maintain the highest sensitivity and follow-through in preserving our natural resources today, and more importantly, for our future generations.

We have chosen suppliers that share this same commitment. Particleboard, the foundation of our furniture design, is manufactured from 100% recycled post-industrial materials. We ensure it is low formaldehyde emission particleboard, use water-based adhesives that are non-toxic in lamination, and band any exposed edges to seal the substrate.

To reduce materials in landfill sites, we integrate remaining cuttings into smaller products or packaging material. Our sawdust is recycled for use on local farms. We use recycled cardboard in all our packaging. NOVA also recycles cardboard, paper, plastics, steel, and aluminum. Even our Visual Display Options (Downview technology and The Trolley™) are completely recyclable.

NOVA continually evaluates all initiatives for improving our environmental accountability while providing the highest quality products to our customers.

Classroom Training





Classroom Training

These products are uniquely suited for the following environments...

- K-12 Classrooms
- College & University Classrooms
- Technical Schools
- Private Training & Tutoring Companies
- Lecture Halls
- Testing Centers
- Corporate Training Rooms
- Government Training Facilities
- Government & Private Security Centers
- Libraries
- Computer Labs
- Common Areas & Lobbies
- Healthcare Facilities
- Correctional Institutions

Smart tools. Smart thinking.

Flat PVC edge banding
Thermofused laminate top
Metal or laminate bases

Classroom Training

Workstations with Total Access iMod

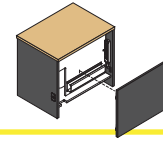

Features, Benefits and Solutions

- Solutions for all learning environments
- Visual Display Options available
- Work surface thickness: 1"
- Standard edge detail: 2mm Flat PVC
- ADA compliant desks available
- Total Access iMod compartment with removable modesty panels (locking optional) for easier networking
- Matching edge banding colors
- Wire management system and power strip included
- Manufactured with recycled post-industrial materials
- Metal ends use 1" square tubing

How To Order

1. Select model number

Ex: 46-SM303630RX

- To specify an **ADA Height** unit, change height from 30 to **32** in model number and add \$196 for single workstation or \$293 for double workstation. Ex: 46-SM3036**32**RX

2. Select laminate or metal base and laminate work surface color (see page 59)

Ex: 227 044
Base Worksurface

3. Select metal color for removable metal iMod modesty or laminate base color for removable laminate iMod modesty

Ex: PSL (Polished silver metal color for metal modesty)
227 (Fashion Grey laminate color for laminate modesty)

OPTIONS

4. Select visual display options (see page 15)

Ex: TE0724NK (The Trolley E with Nova keyboard drawer)

5. Select essential options (see page 54)

Ex: RWG01 (Round wire grommet)

Please Note:

Power strip, wire management and CPU storage shelf are included in Total Access iMod workstations. To indicate no power strip, add -X to model number and deduct \$50 from list price for a single desk and \$100 for a double.

Model Number Structure



46-SM303630RX

46	-	SM	303630	R	X
Series		Type	Size	CPU	Location
SM...		Single desk/ Metal iMod	D x W x H		R-Right L-Left X-No CPU
DM ..		Double desk/ Metal iMod			
SL....		Single desk/ Laminate iMod			
DL....		Double desk/ Laminate iMod			

CPU Storage - Maximum Widths

When adding a Trolley E or 21" Wide Downview Visual Display Option:

32" W Unit = 7 7/16"

36" W Unit = 8 1/2"

42" W Unit = 8 1/2"

63" W Unit = 7 7/16"

71" W Unit = 8 1/2"

When adding a Trolley EXL or 24" Wide Downview Visual Display Option:

32" W Unit = 4"

36" W Unit = 6 3/4"

42" W Unit = 8 1/2"

63" W Unit = 4"

71" W Unit = 6 3/4"

18"W Downview or No Visual Display Option

All Widths = 8 1/2"

Visual Display Options To order, see page 15.

The Trolley™ Personal Monitor Arm System

Maximum dimensions for widescreen:

EXL: 2½" D x 22 7/8" W x 14½" H

E: 2½" D x 18 7/8" W x 14 1/2" H

NOTE: Maximum distance from center of wall mount VESA plate to bottom of monitor is 6 ¾" (171mm)

Downview™

Maximum dimensions for widescreen--

18x18 viewport: 17"W x 14½"H (432mm W x 368mm H)

21x21 viewport: 20½"W x 19"H (511mm W x 483mm H)

16x21 widescreen viewport: 19½"W x 12½" H (495mm W x 318mm H)

18x21 widescreen viewport: 20½"W x 14½"H (511mm W x 368mm H)

21x24 widescreen viewport: 22½"W x 19"H (572mm W x 482mm H)

Surface Mount Arm

Maximum weight for widescreen: 21 lbs.

Maximum dimensions for widescreen: Up to 24" diagonal widescreen



NOVALinked™ is a networking system that provides complete control of NOVA's Trolley E monitor lifts in a classroom or training room setting. To order, see page 26.

Work Surface Edge Detail

Standard
Flat PVC edge 2mm
1" thick



End Styles Straight end panels are standard.

Panel Ends

Standard
Straight End Panels

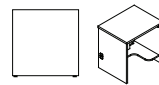

Optional
Contour End Panels - Specify "S"



Add to list price \$99 for a single desk, and \$147 for a double desk for Contour End Panels.

Metal Ends

Optional

Metal Ends - Specify "M" and a metal color

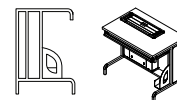

Add to list price \$292 for a single desk, and \$438 for a double desk for Metal Ends.

If finishing end caps are needed, see page 14 to order.

Grommets

Standard grommets in end panels are rectangular black plastic.

To order, specify:

1. Model number
2. Laminate base and worksurface colors
3. Color for removable metal or laminate iMod modesty
4. CPU / Monitor Dimensions
5. Optional - Select visual display option(s)
6. Optional - Add essential accessory options

Visual Display Options available:

- The Trolley™ E / EXL
- Downview-Flat Panel Display
- Surface Mount Flat Panel Display

Workstations with Perforated Metal Total Access iMod Modesty

Specify colors for worksurface, base and removable metal iMod modesty

Suggested Keyboard Width:

SINGLES • 32" W Unit = 30" KB • 36" W, 42" W Unit = 34" KB
DOUBLES • 63" W Unit = 30" KB • 71" = 34" KB

CPU Storage Shelf Width: See "How to Order" page.

D x W x H (in.)	ft ³ / lbs	Model	List Price
Single perforated metal modesty			
Monitor LEFT, CPU storage right			
• Available with casters (Specify "C" and add \$100)			
24 x 32 x 30	16.4 / 125	46-SM243230RX	\$1,029
24 x 36 x 30	18.3 / 133	46-SM243630RX	\$1,085
24 x 42 x 30	21.2 / 144	46-SM244230RX	\$1,276
26 x 32 x 30	17.7 / 130	46-SM263230RX	\$1,087
26 x 36 x 30	19.8 / 138	46-SM263630RX	\$1,145
26 x 42 x 30	22.9 / 150	46-SM264230RX	\$1,347
30 x 32 x 30	20.2 / 140	46-SM303230RX	\$1,206
30 x 36 x 30	22.6 / 148	46-SM303630RX	\$1,272
30 x 42 x 30	26.1 / 161	46-SM304230RX	\$1,495

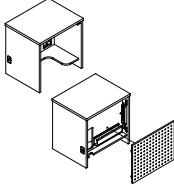

D x W x H (in.)	ft ³ / lbs	Model	List Price
Double perforated metal modesty			
Monitors LEFT, CPU storage right			
• Available with casters (Specify "C" and add \$150)			
24 x 63 x 30	31.3 / 232	46-DM246330RX	\$1,883
24 x 71 x 30	35.2 / 248	46-DM247130RX	\$1,996
26 x 63 x 30	33.8 / 240	46-DM266330RX	\$1,984
26 x 71 x 30	37.9 / 256	46-DM267130RX	\$2,104
30 x 63 x 30	38.6 / 257	46-DM306330RX	\$2,204
30 x 71 x 30	43.3 / 273	46-DM307130RX	\$2,337

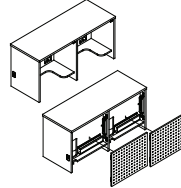

Workstations with Laminate Total Access iMod Modesty

Specify colors for worksurface, base and removable laminate iMod modesty (base color only)

Suggested Keyboard Width:

SINGLES • 32" W Unit = 30" KB • 36" W, 42" W Unit = 34" KB
DOUBLES • 63" W Unit = 30" KB • 71" = 34" KB

CPU Storage Shelf Width: See "How to Order" page.

D x W x H (in.)	ft ³ / lbs	Model	List Price
Single laminate modesty			
Monitor LEFT, CPU storage right			
• Available with casters (Specify "C" and add \$100)			
24 x 32 x 30	16.4 / 125	46-SL243230RX	\$636
24 x 36 x 30	18.3 / 133	46-SL243630RX	\$648
24 x 42 x 30	21.2 / 144	46-SL244230RX	\$842
26 x 32 x 30	17.7 / 130	46-SL263230RX	\$670
26 x 36 x 30	19.8 / 138	46-SL263630RX	\$682
26 x 42 x 30	22.9 / 150	46-SL264230RX	\$874
30 x 32 x 30	20.2 / 140	46-SL303230RX	\$704
30 x 36 x 30	22.6 / 148	46-SL303630RX	\$714
30 x 42 x 30	26.1 / 161	46-SL304230RX	\$907

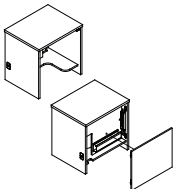

D x W x H (in.)	ft ³ / lbs	Model	List Price
Double laminate modesty			
Monitors LEFT, CPU storage right			
• Available with casters (Specify "C" and add \$150)			
24 x 63 x 30	31.3 / 232	46-DL246330RX	\$1,238
24 x 71 x 30	35.2 / 248	46-DL247130RX	\$1,311
26 x 63 x 30	33.8 / 240	46-DL266330RX	\$1,298
26 x 71 x 30	37.9 / 256	46-DL267130RX	\$1,344
30 x 63 x 30	38.6 / 257	46-DL306330RX	\$1,356
30 x 71 x 30	43.3 / 273	46-DL307130RX	\$1,377

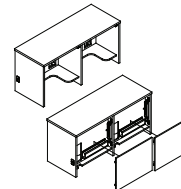

ADA Workstations with Electric Hydraulic Lifts

Electrically adjustable base height from 30" with 2 1/2" travel. Specify colors for worksurface, base and removable metal or laminate iMod modesty.

- Available with contoured end panels (Specify "S" & add \$99)
- Specify "AX" for no CPU shelf

D x W x H (in.)	ft ³ / lbs	Model	List Price
Perforated metal modesty			
24 x 36 x 30	18.3 / 133	46-SM243630AD	\$4,445
24 x 42 x 30	21.2 / 144	46-SM244230AD	\$4,636
26 x 36 x 30	19.8 / 138	46-SM263630AD	\$4,505
26 x 42 x 30	22.9 / 150	46-SM264230AD	\$4,707
30 x 36 x 30	20.2 / 140	46-SM303630AD	\$4,632
30 x 42 x 30	22.6 / 148	46-SM304230AD	\$4,855

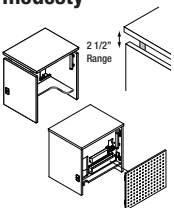

D x W x H (in.)	ft ³ / lbs	Model	List Price
Laminate modesty			
24 x 36 x 30	18.3 / 133	46-SL243630AD	\$4,008
24 x 42 x 30	21.2 / 144	46-SL244230AD	\$4,202
26 x 36 x 30	19.8 / 138	46-SL263630AD	\$4,042
26 x 42 x 30	22.9 / 150	46-SL264230AD	\$4,234
30 x 36 x 30	20.2 / 140	46-SL303630AD	\$4,074
30 x 42 x 30	22.6 / 148	46-SL304230AD	\$4,266

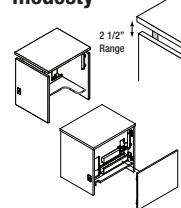

Flat PVC edge banding
Thermofused laminate top
Metal or laminate bases

Classroom Training

Curved Workstations with Total Access iMod

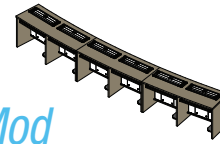

How To Order

1. Select model number

Ex: 46-CM303630RX60

- To specify an **ADA Height** unit, change height from 30 to **32** in model number and add \$196 for single workstation or \$293 for double workstation. Ex: 46-CM303632RX60

2. Select laminate base and work surface color (see page 59)

Ex: 227 044
Base Worksurface

3. Select metal color for removable metal iMod modesty or laminate base color for removable laminate iMod modesty

Ex: PSL (Polished silver metal color for metal modesty)
227 (Fashion Grey laminate color for laminate modesty)

OPTIONS

4. Select visual display options (see page 15)

Ex: TE0724NK (The Trolley E with Nova keyboard drawer)

5. Select essential options (see page 54)

Ex: RWG01 (Round wire grommet)

Please Note:

Power strip, wire management and CPU storage shelf are included in iMod workstations.

Model Number Structure

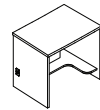

46-CM303630RX60

46 - CM 303630 R X 60

Type
CM... Curved workstation
Metal iMod
CL... Curved workstation
Laminate iMod

When ordering Curved Workstations, specify Arc radius
48 - 48 ft. Radius Arc
60 - 60 ft. Radius Arc
72 - 72 ft. Radius Arc

CPU Storage - Maximum Widths

When adding a Trolley E or 21" Wide Downview Visual Display Option:

32" W Unit = 7 7/16" 48" W Unit = 8 1/2"
36" W Unit = 8 1/2" 63" W Unit = 7 7/16"
42" W Unit = 8 1/2" 71" W Unit = 8 1/2"

When adding a Trolley EXL or 24" Wide Downview Visual Display Option:

32" W Unit = 4" 48" W Unit = 8 1/2"
36" W Unit = 6 3/4" 63" W Unit = 4"
42" W Unit = 8 1/2" 71" W Unit = 6 3/4"

18"W Downview or No Visual Display Option

All Widths = 8 1/2"



NOVALinked™ is a networking system that provides complete control of NOVA's Trolley E monitor lifts in a classroom or training room setting. To order, see page 26.

48 ft. Radius Arc

To specify a 48-ft. Radius Arc desk, add -48 to end of model no. (Ex. 46-CM246330RX48)

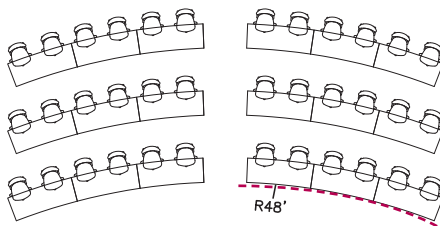

Seated side

(30"D) 2'-9 11/16"	(30"D) 3'-1 7/8"	(30"D) 3'-8 3/16"
(26"D) 2'-9 7/16"	(26"D) 3'-1 5/8"	(26"D) 3'-7 7/8"
(24"D) 2'-9 5/16"	(24"D) 3'-1 1/2"	(24"D) 3'-7 3/4"

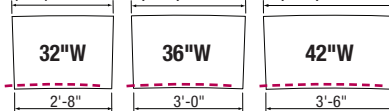

Approach side

Model number width listed is based on the approach side (iMod modesty side) of workstation.

Seated side

(30"D) 5'-6 1/8"	(30"D) 6'-2 9/16"
(26"D) 5'-5 11/16"	(26"D) 6'-2 1/16"
(24"D) 5'-5 1/2"	(24"D) 6'-1 13/16"

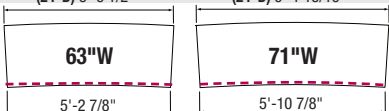

Approach side

Model number width listed is based on the approach side (iMod modesty side) of workstation.

60 ft. Radius Arc

To specify a 60-ft. Radius Arc desk, add -60 to end of model no. (Ex. 46-CM246330RX60)

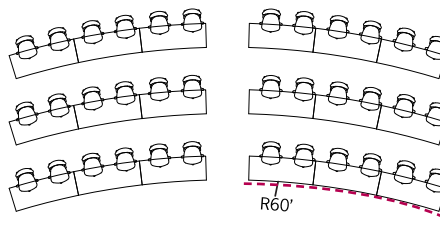

Seated side

(30"D) 2'-9 5/16"	(30"D) 3'-1 1/2"	(30"D) 3'-7 3/4"
(26"D) 2'-9 1/8"	(26"D) 3'-1 5/16"	(26"D) 3'-7 1/2"
(24"D) 2'-9 1/16"	(24"D) 3'-1 3/16"	(24"D) 3'-7 3/8"

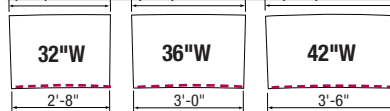

Approach side

Model number width listed is based on the approach side (iMod modesty side) of workstation.

Seated side

(30"D) 5'-5 1/2"	(30"D) 6'-1 13/16"
(26"D) 5'-5 1/8"	(26"D) 6'-1 7/16"
(24"D) 5'-5"	(24"D) 6'-1 1/4"



Approach side

Model number width listed is based on the approach side (iMod modesty side) of workstation.

72 ft. Radius Arc

To specify a 72-ft. Radius Arc desk, add -72 to end of model no. (Ex. 46-CM246330RX72)

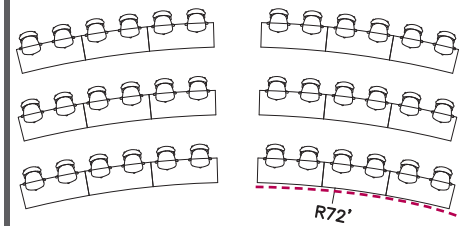

Seated side

(30"D) 2'-9 1/8"	(30"D) 3'-1 1/4"	(30"D) 3'-7 7/16"
(26"D) 2'-8 15/16"	(26"D) 3'-1 1/16"	(26"D) 3'-7 1/4"
(24"D) 2'-8 7/8"	(24"D) 3'-1"	(24"D) 3'-7 3/16"

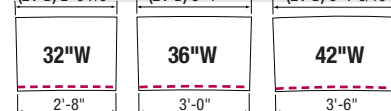

Approach side

Model number width listed is based on the approach side (iMod modesty side) of workstation.

Seated side

(30"D) 5'-5 1/16"	(30"D) 6'-1 5/16"
(26"D) 5'-4 3/4"	(26"D) 6'-1"
(24"D) 5'-4 5/8"	(24"D) 6'-0 7/8"



Approach side

Model number width listed is based on the approach side (iMod modesty side) of workstation.

To order, specify:

1. Model number
2. Base and worksurface colors
3. Color for removable metal or laminate iMod modesty
4. CPU / Monitor Dimensions
5. Optional - Select visual display option(s)
6. Optional - Add essential accessory options

Visual Display Options available:

- The Trolley™ E / EXL
- Downview-Flat Panel Display
- Surface Mount Flat Panel Display

Curved Workstations with Perforated Metal Total Access iMod Modesty

Specify colors for worksurface, base and removable metal iMod modesty.
Specify arc radius with either 48, 60 or 72 at end of model number. [Ex. 46-CM243630RX48]

Suggested Keyboard Width: 27" KB CPU Storage Shelf Width: See "How to Order" page.

Single perforated metal modesty

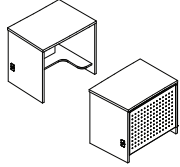

D x W x H (in.)	ft³ / lbs	Model	Arc Radius	List Price
Monitor LEFT, CPU storage right				
• Available with casters (Specify "C" and add \$100)				
24 x 32 x 30	16.4 / 125	46-CM243230RX		\$1,664
24 x 36 x 30	18.3 / 133	46-CM243630RX		\$1,733
24 x 42 x 30	21.2 / 144	46-CM244230RX		\$2,117
26 x 32 x 30	17.7 / 130	46-CM263230RX		\$1,757
26 x 36 x 30	19.8 / 138	46-CM263630RX		\$1,827
26 x 42 x 30	22.9 / 150	46-CM264230RX		\$2,221
30 x 32 x 30	20.2 / 140	46-CM303230RX		\$1,909
30 x 36 x 30	22.6 / 148	46-CM303630RX		\$1,986
30 x 42 x 30	26.1 / 161	46-CM304230RX		\$2,401

Double perforated metal modesty

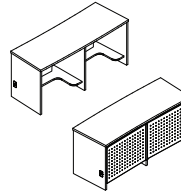

D x W x H (in.)	ft³ / lbs	Model	Arc Radius	List Price
Monitors LEFT in workspace, CPU storage right				
• Available with casters (Specify "C" and add \$150)				
24 x 63 x 30	31.3 / 232	46-CM246330RX		\$3,121
24 x 71 x 30	35.2 / 248	46-CM247130RX		\$3,306
26 x 63 x 30	33.8 / 240	46-CM266330RX		\$3,282
26 x 71 x 30	37.9 / 256	46-CM267130RX		\$3,448
30 x 63 x 30	38.6 / 257	46-CM306330RX		\$3,559
30 x 71 x 30	43.3 / 273	46-CM307130RX		\$3,714

Curved Workstations with Laminate Total Access iMod Modesty

Specify colors for worksurface, base and removable laminate iMod modesty (base color only)
Specify arc radius with either 48, 60 or 72 at end of model number. [Ex. 46-CL243630RX48]

Suggested Keyboard Width: 27" KB CPU Storage Shelf Width: See "How to Order" page.

Single laminate modesty

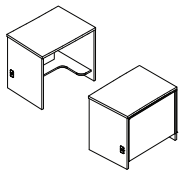

D x W x H (in.)	ft³ / lbs	Model	Arc Radius	List Price
Monitor LEFT, CPU storage right				
• Available with casters (Specify "C" and add \$100)				
24 x 32 x 30	16.4 / 125	46-CL243230RX		\$1,271
24 x 36 x 30	18.3 / 133	46-CL243630RX		\$1,296
24 x 42 x 30	21.2 / 144	46-CL244230RX		\$1,683
26 x 32 x 30	17.7 / 130	46-CL263230RX		\$1,340
26 x 36 x 30	19.8 / 138	46-CL263630RX		\$1,363
26 x 42 x 30	22.9 / 150	46-CL264230RX		\$1,748
30 x 32 x 30	20.2 / 140	46-CL303230RX		\$1,407
30 x 36 x 30	22.6 / 148	46-CL303630RX		\$1,428
30 x 42 x 30	26.1 / 161	46-CL304230RX		\$1,813

Double laminate modesty

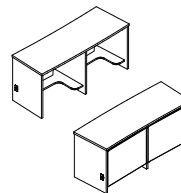

D x W x H (in.)	ft³ / lbs	Model	Arc Radius	List Price
Monitors LEFT in workspace, CPU storage right				
• Available with casters (Specify "C" and add \$150)				
24 x 63 x 30	31.3 / 232	46-CL246330RX		\$2,476
24 x 71 x 30	35.2 / 248	46-CL247130RX		\$2,621
26 x 63 x 30	33.8 / 240	46-CL266330RX		\$2,595
26 x 71 x 30	37.9 / 256	46-CL267130RX		\$2,644
30 x 63 x 30	38.6 / 257	46-CL306330RX		\$2,711
30 x 71 x 30	43.3 / 273	46-CL307130RX		\$2,754

Curved ADA Workstations with Electric Hydraulic Lifts

Electrically adjustable base height from 30" with 2 1/2" travel. Specify colors for worksurface, base and removable metal or laminate Total Access iMod modesty.

• Available with contoured end panels (Specify "S" & add \$99)

Perforated metal modesty

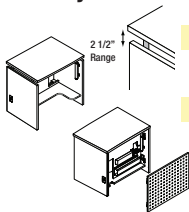

D x W x H (in.)	ft³ / lbs	Model	Arc Radius	List Price
24 x 36 x 30	18.3 / 133	46-CM243630AD		\$5,093
24 x 42 x 30	21.2 / 144	46-CM244230AD		\$5,477
26 x 36 x 30	19.8 / 138	46-CM263630AD		\$5,187
26 x 42 x 30	22.9 / 150	46-CM264230AD		\$5,581
30 x 36 x 30	20.2 / 140	46-CM303630AD		\$5,345
30 x 42 x 30	22.6 / 148	46-CM304230AD		\$5,091

Laminate modesty

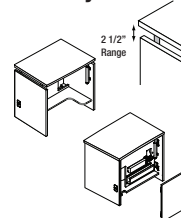

D x W x H (in.)	ft³ / lbs	Model	Arc Radius	List Price
24 x 36 x 30	18.3 / 133	46-CL243630AD		\$4,656
24 x 42 x 30	21.2 / 144	46-CL244230AD		\$5,043
26 x 36 x 30	19.8 / 138	46-CL263630AD		\$4,675
26 x 42 x 30	22.9 / 150	46-CL264230AD		\$5,108
30 x 36 x 30	20.2 / 140	46-CL303630AD		\$4,788
30 x 42 x 30	22.6 / 148	46-CL304230AD		\$5,173

Flat PVC edge banding
Thermofused laminate top
Metal or laminate bases

Classroom Training

Workstations with Total Access iMod

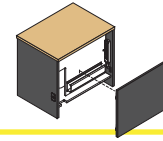

How To Order

1. Select model number

Ex: 46-SM303630RX

- To specify an **ADA Height** unit, change height from 30 to **32** in model number and add \$196 for single workstation or \$293 for double workstation. Ex: 46-SM303632RX

2. Select laminate base and work surface color (see page 59)

Ex: 227 044

Base Worksurface

3. Select metal color for removable metal iMod modesty or laminate base color for removable laminate iMod modesty

Ex: PSL (Polished silver metal color for metal modesty)

227 (Fashion Grey laminate color for laminate modesty)

OPTIONS

4. Select visual display options (see page 15)

Ex: TE0724NK (The Trolley E with Nova keyboard drawer)

5. Select essential options (see page 54)

Ex: RWG01 (Round wire grommet)

Teacher's Stand-up Desks

Suggested Keyboard Width: 34" KB
CPU Storage Shelf Width: See "How to Order" page.

Stand-up height. Monitor left, CPU storage right. Specify colors for worksurface, base and removable metal or laminate Total Access iMod modesty.

- Available with **heavy duty casters** (Specify "C" and add \$366)
Height will increase by 2 3/4".
- Available with **Flip-up Shelf**. For factory prep, must specify "U" for left-handed or "V" for right-handed placement.

D x W x H (in.)	ft ³ / lbs	Model	List Price
-----------------	-----------------------	-------	------------

Laminate Modesty

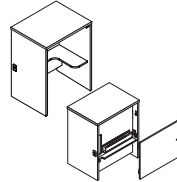

36" W & 42" W Workstation

24 x 36 x 40	24.1 / 130	46-SL243640RX	\$1,036
24 x 42 x 40	27.9 / 152	46-SL244240RX	\$1,212
24 x 48 x 40	31.6 / 158	46-SL244840RX	\$1,270
30 x 36 x 40	29.6 / 149	46-SL303640RX	\$1,090
30 x 42 x 40	34.3 / 172	46-SL304240RX	\$1,267
30 x 48 x 40	38.9 / 179	46-SL304840RX	\$1,325
36 x 36 x 40	35.1 / 176	46-SL363640RX	\$1,433
36 x 42 x 40	40.7 / 193	46-SL364240RX	\$1,495
36 x 48 x 40	46.2 / 200	46-SL364840RX	\$1,564

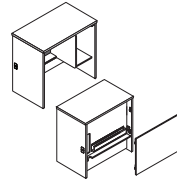

48" W Workstation

Perforated Metal Modesty

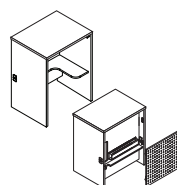

36" W & 42" W Workstation

24 x 36 x 40	24.1 / 130	46-SM243640RX	\$1,326
24 x 42 x 40	27.9 / 152	46-SM244240RX	\$1,502
24 x 48 x 40	31.6 / 158	46-SM244840RX	\$1,560
30 x 36 x 40	29.6 / 149	46-SM303640RX	\$1,380
30 x 42 x 40	34.3 / 172	46-SM304240RX	\$1,558
30 x 48 x 40	38.9 / 179	46-SM304840RX	\$1,614
36 x 36 x 40	35.1 / 176	46-SM363640RX	\$1,722
36 x 42 x 40	40.7 / 193	46-SM364240RX	\$1,785
36 x 48 x 40	46.2 / 200	46-SM364840RX	\$1,854

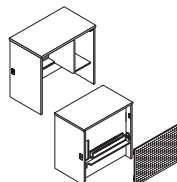

48" W Workstation

Workstations - Monitor CENTER

Suggested Keyboard Width: 34"
CPU Storage Shelf Width: 11"

Monitor center, CPU storage right. Specify colors for worksurface, base and removable metal or laminate Total Access iMod modesty

- Available with **contoured end panels** (Specify "S" & add \$99)
- Available with **casters** (Specify "C" & add \$100)

D x W x H (in.)	ft ³ / lbs	Model	List Price
-----------------	-----------------------	-------	------------

Laminate Modesty

24 x 48 x 30	24.1 / 139	46-SL244830RXC	\$1,011
30 x 48 x 30	29.7 / 156	46-SL304830RXC	\$1,077
36 x 48 x 30	35.2 / 173	46-SL364830RXC	\$1,274

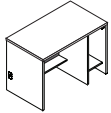

Perforated Metal Modesty

24 x 48 x 30	24.1 / 139	46-SM244830RXC	\$1,301
30 x 48 x 30	29.7 / 156	46-SM304830RXC	\$1,368
36 x 48 x 30	35.2 / 173	46-SM364830RXC	\$1,563

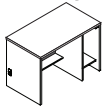

ADA Compliant Workstation - Monitor CENTER

Suggested Keyboard Width: 34"
CPU Storage Shelf Width: 11"

Monitor center, CPU storage right. Specify colors for worksurface, base and removable metal or laminate Total Access iMod modesty

Laminate Modesty

30 x 48 x 32	31.5 / 165	46-AL304832RXC	\$1,273
--------------	------------	----------------	---------

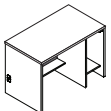

Perforated Metal Modesty

30 x 48 x 32	31.5 / 165	46-AM304832RXC	\$1,563
--------------	------------	----------------	---------

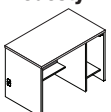

To order, specify:

1. Model number
2. Laminate base and worksurface colors
3. Color for removable metal or laminate iMod modesty
4. CPU / Monitor Dimensions
5. Optional - Select visual display option(s)
6. Optional - Add essential accessory options

Visual Display Options available:

- The Trolley™ E / EXL
- Downview-Flat Panel Display
- Surface Mount Flat Panel Display

Split Top Workstations

Suggested Keyboard Width: 34" KB
CPU Storage Shelf Width: See "How to Order" page.

6" D x 27" H shelf intended for a flat panel monitor with base.

Monitor left, CPU storage right.

Specify colors for worksurface, base and removable metal or laminate Total Access iMod modesty.

- Available with contoured end panels (Specify "S" & add \$99 for a Single Workstation and add \$147 for a Double Workstation)
- Available with casters (Specify "C" & add \$100 for Single Workstation & add \$150 for Double Workstation)
- Available with Surface Mount Arm (SMA0203NK) VDO only

D x W x H (in.)	ft ³ / lbs	Model	List Price
-----------------	-----------------------	-------	------------

Laminate Modesty

Single, Monitor Left, CPU Storage right			
24 x 36 x 30	18.3 / 123	46-SL243630ST	\$903
24 x 42 x 30	21.2 / 130	46-SL244230ST	\$1,127
Double, Monitors Left in workspace, CPU Storage right			
30 x 36 x 30	22.6 / 138	46-SL303630ST	\$970
30 x 42 x 30	26.1 / 145	46-SL304230ST	\$1,194

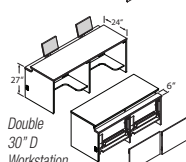
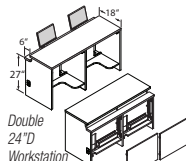
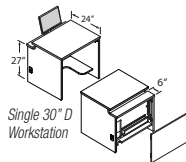

24 x 63 x 30	31.3 / 200	46-DL246330ST	\$1,425
24 x 71 x 30	35.2 / 212	46-DL247130ST	\$1,523
30 x 63 x 30	38.6 / 220	46-DL306330ST	\$1,491
30 x 71 x 30	43.3 / 234	46-DL307130ST	\$1,596

D x W x H (in.)	ft ³ / lbs	Model	List Price
-----------------	-----------------------	-------	------------

Perforated Metal Modesty

Single, Monitor Left, CPU Storage right			
24 x 36 x 30	18.3 / 123	46-SM243630ST	\$1,194
24 x 42 x 30	21.2 / 130	46-SM244230ST	\$1,416
30 x 36 x 30	22.6 / 138	46-SM303630ST	\$1,260
30 x 42 x 30	26.1 / 145	46-SM304230ST	\$1,483

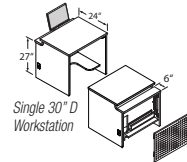
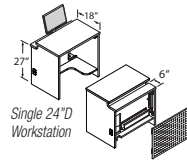

Double, Monitors Left in workspace, CPU Storage right			
24 x 63 x 30	31.3 / 200	46-DM246330ST	\$2,005
24 x 71 x 30	35.2 / 212	46-DM247130ST	\$2,103
30 x 63 x 30	38.6 / 220	46-DM306330ST	\$2,076
30 x 71 x 30	43.3 / 234	46-DM307130ST	\$2,175

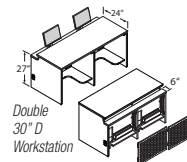
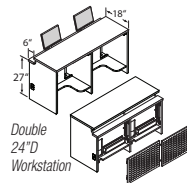

Factory Installed Keyboard Options

(Only ordered when NO Visual Display Options ordered)

Factory Installed Nova Keyboard	Keyboard length to fit casegoods ordered			
	22" - 34" wide	13	NK	\$123

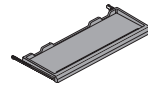

Factory Installed Center Mount Articulating Keyboard Mechanism & Tray	Keyboard length to fit casegoods ordered			
	28", 30", 34" wide	15	CK	\$256

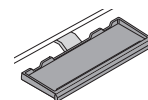

Flat PVC edge banding
Thermofused laminate top
Metal or laminate bases

Classroom Training

Workstations with Total Access iMod

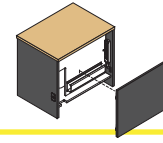

How To Order

1. Select model number

Ex: 46-SM303630RX

- To specify an **ADA Height** unit, change height from 30 to **32** in model number and add \$196 for single workstation or \$293 for double workstation. Ex: 46-SM303632RX

2. Select laminate base and work surface color (see page 59)

Ex: 227 044
Base Worksurface

3. Select metal color for removable metal iMod modesty or laminate base color for removable laminate iMod modesty

Ex: PSL (Polished silver metal color for metal modesty)
227 (Fashion Grey laminate color for laminate modesty)

OPTIONS

4. Select visual display options (see page 15)

Ex: TE0724NK (The Trolley E with Nova keyboard drawer)

5. Select essential options (see page 54)

Ex: RWG01 (Round wire grommet)

Miscellaneous

D x W x H (in.)	ft ³ / lbs	Model	List Price
-----------------	-----------------------	-------	------------

Flip-up shelf



Shipped Separately. Color matches work surface of unit ordered. Located 3" down from work surface.

For 24" & 26" Deep Workstations—
Attaches to the **LEFT** side panel of desk.

20 x 20 x 01	1.0 / 14	46-SH202001L	\$511
--------------	----------	--------------	-------

Attaches to the **RIGHT** side panel of desk.

20 x 20 x 01	1.0 / 14	46-SH202001R	\$511
--------------	----------	--------------	-------

For 30" Deep Workstations—

Attaches to the **LEFT** side panel of desk.

22 x 20 x 01	1.0 / 14	46-SH222001L	\$511
--------------	----------	--------------	-------

Attaches to the **RIGHT** side panel of desk.

22 x 20 x 01	1.0 / 14	46-SH222001R	\$511
--------------	----------	--------------	-------

Locking options



To specify a locking CPU Door, replace "X" in the model number with "D" and add \$351 for a single desk and \$701 for a double desk.

Example: 46-SM243630RX becomes 46-SM243630RD

- Not available on workstations 32" or 63" wide
- Not available in combination with Contoured End Panels (-S)
- Will lose 1-1/2" W CPU Space

-D	\$351 / Single desk	\$701 / Double desk
----	---------------------	---------------------

Miscellaneous

D x W x H (in.)	ft ³ / lbs	Model	List Price
-----------------	-----------------------	-------	------------

Casters



Includes stabilization bracket.

Single Workstation / Set of 4 (all locking)

2 5/8 x 1 3/4 x 3 1/4	-C	\$100/set
-----------------------	----	-----------

Double Workstation / Set of 6

2 5/8 x 1 3/4 x 3 1/4	-C	\$150/set
-----------------------	----	-----------

Teacher Standup / Set of 4.

Heavy duty caster. Will increase height by 2 3/4"

3-1/2 x 03 x 4	-C	\$366/set
----------------	----	-----------

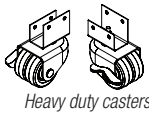

Heavy duty casters

Contoured end panels

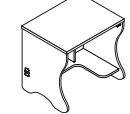

Not available on workstations with Locking Door option (-D)
-S \$99/Single desk
\$147/Double desk

Metal end

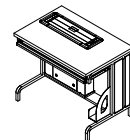

Not available on workstations with Locking Door option (-D)
-M \$292 / Single desk
\$438 / Double desk

Finishing end caps for metal end style

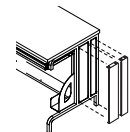

Fits on right or left open end of metal end. One 2 11/16" W and one 4 3/8" W end cap. Specify metal color.
01 x 08 x 23 0.1 / 3 46-08END23 \$125 / set

Rectangular Wire Grommet



Black plastic grommet cover is removable for easy wire management. If Installed (available for work surface only):
Please provide sketch to indicate placement location

17/8 x 3 1/4 x 1 1/4 (cutout dimensions)	WG1080	\$72
--	--------	------

If Sold Separately (not part of base model):

17/8 x 3 1/4 x 1 1/4 (cutout dimensions)	AC-WG1080	\$37
--	-----------	------

For other grommet options, see page 55.

No Powerstrip

Powerstrip included in all workstations by default, to remove:
-X Deduct \$50 / Single desk
Deduct \$100 / Double desk



Locking Modesty Cover

To specify a locking modesty cover, specify "L" and add \$152 for a single desk and \$303 for a double desk. (Locking Modesty included with Locking CPU Door)

Wedges

Hardware included

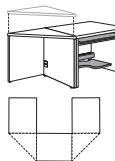

For 24" D units

90 Degree - Includes end panels. Must specify base and work surface color.

24 x 33 1/16 x 30 / 49	46-WG24333090	\$407
------------------------	---------------	-------

For 30" D units

90 Degree - Includes end panels. Must specify base and work surface color.

30 x 42 3/16 x 30 / 63	46-WG30423090	\$434
------------------------	---------------	-------

Privacy Panels for Single Monitor Workstation

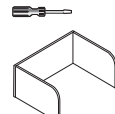

For factory prep, must specify "PP" on desk model number. Specify base color only. 6" radius on front. Field installed.

24 x 32 x 15	1.3 / 36	46-PP243215	\$357
--------------	----------	-------------	-------

24 x 36 x 15	1.5 / 37	46-PP243615	\$370
--------------	----------	-------------	-------

24 x 42 x 15	1.7 / 40	46-PP244215	\$405
--------------	----------	-------------	-------

24 x 48 x 15	1.9 / 42	46-PP244815	\$448
--------------	----------	-------------	-------

26 x 32 x 15	1.3 / 37	46-PP263215	\$375
--------------	----------	-------------	-------

26 x 36 x 15	1.5 / 38	46-PP263615	\$387
--------------	----------	-------------	-------

26 x 42 x 15	1.7 / 41	46-PP264215	\$424
--------------	----------	-------------	-------

26 x 48 x 15	1.9 / 43	46-PP264815	\$465
--------------	----------	-------------	-------

30 x 32 x 15	1.3 / 40	46-PP303215	\$397
--------------	----------	-------------	-------

30 x 36 x 15	1.5 / 42	46-PP303615	\$409
--------------	----------	-------------	-------

30 x 42 x 15	1.7 / 44	46-PP304215	\$451
--------------	----------	-------------	-------

30 x 48 x 15	1.9 / 47	46-PP304815	\$496
--------------	----------	-------------	-------

Privacy Panels for Double Monitor Workstation

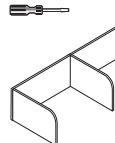

For factory prep, must specify "PP" on desk model number. Specify base color only. 6" radius on front. Field installed.

24 x 63 x 15	1.6 / 48	46-PP246315	\$562
--------------	----------	-------------	-------

24 x 71 x 15	1.8 / 51	46-PP247115	\$632
--------------	----------	-------------	-------

26 x 63 x 15	1.6 / 49	46-PP266315	\$580
--------------	----------	-------------	-------

26 x 71 x 15	1.8 / 52	46-PP267115	\$651
--------------	----------	-------------	-------

30 x 63 x 15	1.6 / 52	46-PP306315	\$618
--------------	----------	-------------	-------

30 x 71 x 15	1.8 / 55	46-PP307115	\$696
--------------	----------	-------------	-------

30" W Workstation for Surface Mount & Downview only

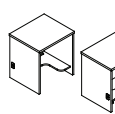

Available with casters (Specify "C" and add \$100)

Single laminate Total Access iMod modesty

24 x 30 x 30	16.4 / 125	46-SL243030RX	\$603
--------------	------------	---------------	-------

26 x 30 x 30	17.7 / 130	46-SL263030RX	\$637
--------------	------------	---------------	-------

30 x 30 x 30	20.2 / 135	46-SL303030RX	\$670
--------------	------------	---------------	-------

Single perforated metal Total Access iMod modesty

24 x 30 x 30	16.4 / 125	46-SM243030RX	\$996
--------------	------------	---------------	-------

26 x 30 x 30	17.7 / 130	46-SM263030RX	\$1,053
--------------	------------	---------------	---------

30 x 30 x 30	20.2 / 135	46-SM303030RX	\$1,172
--------------	------------	---------------	---------

Visual Display Options

Single monitor workstations require one (1) visual display option. Double monitor workstations require two (2) visual display options.

For Workstations with iMod

Factory installed keyboard-only option for Workstations with Total Access iMod available on page 13.

For details and installation specifications, refer to pages 47-51.

For CRT applications, please contact Customer Support: 1-800-730-6682

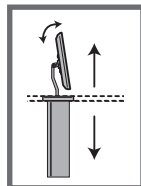

The Trolley™

- Trolley comes installed in most units.
- **26" min. worksurface depth** required for Trolley with **Center Mount Articulating Keyboard Tray**
- **Maximum distance from center of wall mount VESA plate to bottom of monitor is 6 3/4" (171mm)**

The Trolley™ EXL

Maximum Dimensions for Widescreen:

2 1/2" D x 22 7/8" W x 14 1/2" H
up to 24" diagonal widescreen
36" min. worksurface width

- Low voltage motor to lift & lower monitor
- Provides vertical tilt adjustment in "up" position
- Durable metal structure under desktop
- Wire management system and power strip included

The Trolley™ E

Maximum Dimensions for Widescreen:

2 1/2" D x 18 7/8" W x 14 1/2" H
up to 21" (diagonal) or
20" (widescreen)

Model		Wt.	List Price
			Qty 2 required for Double Workstations/Tables
With Nova Keyboard Drawer			
Nova Keyboard Drawer installed in assembled units only.			
TE0728NK	48	The Trolley EXL with Nova Keyboard drawer	\$1,775 ea.
TE0724NK	48	The Trolley E with Nova Keyboard drawer	\$1,339 ea.

With Center Mount Articulating Keyboard Mechanism and Tray

Center Mount Keyboard Tray installed in assembled units only.

26" Min. worksurface depth required.

TE0728CK	47	The Trolley EXL with Center Mount Artic. Keyboard Drawer	\$2,006 ea.
TE0724CK	47	The Trolley E with Center Mount Artic. Keyboard Drawer	\$1,535 ea.

International Customers: Trolleys include Universal Power Control Units, compatible with all power requirements inside and outside the U.S.

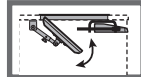

Downview™

18"D x 18"W viewport

Maximum Dimensions for Widescreen: 17"W x 14 1/2"H
up to 19" diagonal
26" min. work surface depth

21"D x 21"W viewport

Maximum Dimensions for Widescreen: 20 1/8"W x 19"H
up to 21" diagonal
30" min. work surface depth

- Tinted, tempered glass viewport
- Keeps monitor under glass below work surface
- Wire management system and power strip included

16"D x 21"W viewport (Widescreen)

Maximum Dimensions for Widescreen: 19 1/2"W x 12 1/2" H
up to 21" widescreen
24" min. work surface depth

18"D x 21"W viewport (Widescreen)

Maximum Dimensions for Widescreen: 20 1/8"W x 14 1/2"H
up to 21" widescreen
26" min. work surface depth

21"D x 24"W viewport (Widescreen)

Maximum Dimensions for Widescreen: 22 1/2"W x 19"H
up to 23" widescreen
30" min. work surface depth
36" min. work surface width

Model		Wt.	List Price
			Qty 2 required for Double Workstations/Tables
With Nova Keyboard Drawer			
Downview & Nova Keyboard Drawer installed in assembled units only.			
FPA1621NK	35	Includes 16"D x 21"W viewport, adjustable arm, and visor.	\$413 ea.
FPA1818NK	35	Includes 18"D x 18"W viewport, adjustable arm, and visor.	\$438 ea.
FPA1821NK	35	Includes 18"D x 21"W viewport, adjustable arm, and visor.	\$438 ea.
FPA2121NK	37	Includes 21"D x 21"W viewport, adjustable arm, and visor.	\$511 ea.
FPA2124NK	39	Includes 21"D x 24"W viewport, adjustable arm, and visor.	\$558 ea.

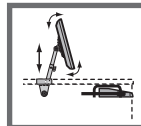

Surface Mount Arm

Surface mount arm does not come installed in any unit

Maximum Weight / Dimensions for Widescreen:

21 lbs. / Up to 24" diagonal widescreen

- Wire management system and power strip included

Model		Wt.	List Price
			Qty 2 required for Double Workstations/Tables
With Nova Keyboard Drawer			
Nova Keyboard Drawer installed in assembled units only.			
SMA0203NK	13		\$317 ea.
With Center Mount Articulating Keyboard Mechanism and Tray			
Center Mount Keyboard Tray installed in assembled units only.			
SMA0203CK	15		\$523 ea.

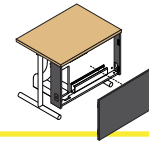

Features, Benefits and Solutions

- Solutions for all learning environments
- Visual Display Options available
- Work surface thickness: 1"
- Standard edge detail: 2mm Flat PVC
- ADA compliant desks available
- Total Access iMod compartment with removable modesty panels (locking optional) for easier networking
- Matching edge banding colors
- Wire management system and power strip included
- Manufactured with recycled post-industrial materials

How To Order

1. Select model number

Ex: 26-RM303630TL

- To specify an **ADA Height** unit, change height from 30 to **32** in model number and add \$196 for single table or \$293 for double table. Ex: 26-RM3036**32**TL
- To specify an **ADA Lift** unit, change model number from R to **A** and add \$4,277 to list price. Ex: 26-**AM**303630TL. Available on single units only.

2. Select metal color for legs and laminate color for work surface (see page 59 & 60)

Ex: PBL 044
Base Worksurface

3. Select metal color for metal iMod modesty or laminate base color for laminate iMod modesty

Ex: PSL (Polished silver metal color for metal modesty)
227 (Fashion Grey laminate color for laminate modesty)

OPTIONS

4. Casters or height-adjustable legs:

For casters, add **-C** to the model number and add \$50 list, per leg.

Ex: 26-RM244830AL-**C**

For height-adjustable legs, add **-H** to the model number and add \$140 list, per leg.

Ex: 26-RM244830AL-**H**

5. Select visual display options (see page 24)

Ex: TE0724NK (The Trolley E with Nova keyboard drawer)

6. Select essential options (see page 54)

Ex: RWG01 (Round wire grommet)

7. Select end caps for iMod table with metal modesty

Ex: 26-ENDCAP22 (End caps)

Specify metal color for end caps

Ex: PSL (Polished silver metal color)

Please Note:

Power strip, wire management and CPU holder are included by default in iMod tables.

For no power strip, add **-X** to the model number and deduct \$50 list, per user.

Ex: 26-RM244230TL-**X**

For no CPU holder, add **-XC** to the model number and deduct \$110 list, per user.

Ex: 26-RM244230TL-**XC**

For Small Form Factor CPU's, contact Customer Service.

Visual Display Options To order, see page 24.

The Trolley™ Personal Monitor Arm System

Maximum dimensions for widescreen:

EXL: 2½" D x 22 7/8" W x 14½" H

E: 2½" D x 18 7/8" W x 14 1/2" H

NOTE: Maximum distance from center of wall mount VESA plate to bottom of monitor is 6 ¾" (171mm)

Downview™

Maximum dimensions for widescreen—

18x18 viewport: 17"W x 14½"H (432mm W x 368mm H)

21x21 viewport: 20⅛"W x 19"H (511mm W x 483mm H)

16x21 widescreen viewport: 19½"W x 12½" H (495mm W x 318mm H)

18x21 widescreen viewport: 20⅛"W x 14½"H (511mm W x 368mm H)

21x24 widescreen viewport: 22½"W x 19"H (572mm W x 482mm H)

Surface Mount Arm

Maximum weight for widescreen: 21 lbs.

Maximum dimensions for widescreen: Up to 24" diagonal widescreen



NOVALinked™ is a networking system that provides complete control of NOVA's Trolley E monitor lifts in a classroom or training room setting. To order, see page 26.

Model Number Structure

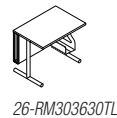

26-RM303630TL

26

Series

- RM

Type

303630

Size

TL

Leg Style

RM - Rectangle top/
Metal iMod
RL - Rectangle top/
Laminate iMod
AM/AL - w/ ADA Lift
(see pg. 18)

D x W x H

AL - Arched leg
TL - T-leg

Leg Base Styles & Options

Styles



Arched leg



T leg

Options



Arched leg
with casters
(-C)

Add \$50 list, per leg



T leg
with casters
(-C)

Add \$50 list, per leg

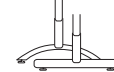

Height-adjustable
legs (-H)

Adjustable height
from 27" - 37"
Specify -H & add \$140
list, per leg

CPU Storage - Maximum Widths

When adding a Trolley E or 21" Wide Downview Visual Display Option:

36" W Unit = 7"

42" W Unit = 7.5"

72" W Unit = 7"

When adding a Trolley EXL or 24" Wide Downview Visual Display Option:

36" W Unit = 4.5"

42" W Unit = 7.5"

72" W Unit = 4.5"

18"W Downview or No Visual Display Option

All Widths = 7.5"

To order, specify:

1. Model number
2. Metal leg color & laminate worksurface colors
3. Metal iMod color -or- base color for laminate iMod
4. CPU / Monitor Dimensions

5. Optional - Ht.-Adjustable Legs or Casters
6. Optional - Select visual display option(s)
7. Optional - Add essential accessory options
8. Optional - Specify End caps for metal iMod & specify color

Visual Display Options available:

- The Trolley™ E / EXL
- Downview-Flat Panel Display
- Surface Mount Flat Panel Display

Tables with Perforated Metal Total Access iMod Modesty (See p. 22 for optional end caps)

Specify colors for worksurface, metal leg and removable metal iMod modesty

Suggested Keyboard Width: 36W & 72W Table = 30" KB • 42W Table = 32" KB

CPU Holder Width: See "How To Order" page.

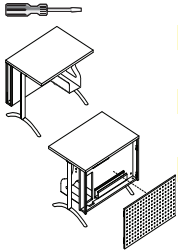
	D x W x H (in.)	ft ³ / lbs	Model	List Price
Arched legs 	Two leg bases - Single metal modesty			
	• Available with casters (Specify "C" and add \$100)			
	24 x 36 x 30	18.3 / 124	26-RM243630AL	\$1,733
	24 x 42 x 30	21.2 / 131	26-RM244230AL	\$1,861
	26 x 36 x 30	19.8 / 126	26-RM263630AL	\$1,776
	26 x 42 x 30	22.9 / 134	26-RM264230AL	\$1,906
	30 x 36 x 30	22.6 / 133	26-RM303630AL	\$1,971
	30 x 42 x 30	26.1 / 142	26-RM304230AL	\$2,116

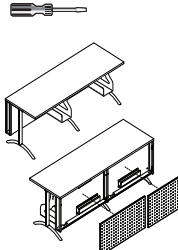
	D x W x H (in.)	ft ³ / lbs	Model	List Price
Arched legs 	Three leg bases - Double metal modesty			
	• Available with casters (Specify "C" and add \$150)			
	24 x 72 x 30	35.7 / 279	26-RM247230AL	\$3,063
	26 x 72 x 30	38.4 / 283	26-RM267230AL	\$3,138
	30 x 72 x 30	43.9 / 292	26-RM307230AL	\$3,482

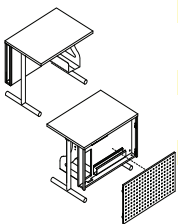
	D x W x H (in.)	ft ³ / lbs	Model	List Price
T legs 	Two leg bases - Single metal modesty			
	• Available with casters (Specify "C" and add \$100)			
	24 x 36 x 30	18.3 / 124	26-RM243630TL	\$1,546
	24 x 42 x 30	21.2 / 131	26-RM244230TL	\$1,670
	26 x 36 x 30	19.8 / 126	26-RM263630TL	\$1,582
	26 x 42 x 30	22.9 / 134	26-RM264230TL	\$1,712
	30 x 36 x 30	22.6 / 133	26-RM303630TL	\$1,758
30 x 42 x 30	26.1 / 142	26-RM304230TL	\$1,899	

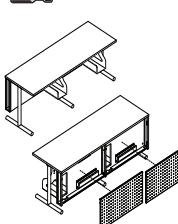
	D x W x H (in.)	ft ³ / lbs	Model	List Price
T legs 	Three leg bases - Double metal modesty			
	• Available with casters (Specify "C" and add \$150)			
	24 x 72 x 30	35.7 / 279	26-RM247230TL	\$2,783
	26 x 72 x 30	38.4 / 283	26-RM267230TL	\$2,848
	30 x 72 x 30	43.9 / 292	26-RM307230TL	\$3,161

Tables with Laminate Total Access iMod Modesty

No end caps required. Finished ends with rectangular black plastic grommets.

Specify colors for worksurface, metal leg and removable laminate iMod modesty (base color only)

Suggested Keyboard Width: 36W & 72W Table = 30" KB • 42W Table = 32" KB

CPU Holder Width: See "How To Order" page.

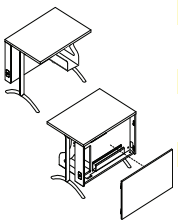
	D x W x H (in.)	ft ³ / lbs	Model	List Price
Arched legs 	Two leg bases - Single laminate modesty			
	• Available with casters (Specify "C" and add \$100)			
	24 x 36 x 30	18.3 / 124	26-RL243630AL	\$1,389
	24 x 42 x 30	21.2 / 131	26-RL244230AL	\$1,492
	26 x 36 x 30	19.8 / 126	26-RL263630AL	\$1,431
	26 x 42 x 30	22.9 / 134	26-RL264230AL	\$1,538
	30 x 36 x 30	22.6 / 133	26-RL303630AL	\$1,589
30 x 42 x 30	26.1 / 142	26-RL304230AL	\$1,707	

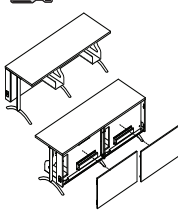
	D x W x H (in.)	ft ³ / lbs	Model	List Price
Arched legs 	Three leg bases - Double laminate modesty			
	• Available with casters (Specify "C" and add \$150)			
	24 x 72 x 30	35.7 / 279	26-RL247230AL	\$2,412
	26 x 72 x 30	38.4 / 283	26-RL267230AL	\$2,484
	30 x 72 x 30	43.9 / 292	26-RL307230AL	\$2,760

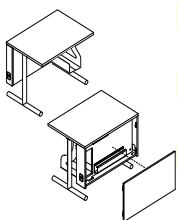
	D x W x H (in.)	ft ³ / lbs	Model	List Price
T legs 	Two leg bases - Single laminate modesty			
	• Available with casters (Specify "C" and add \$100)			
	24 x 36 x 30	18.3 / 124	26-RL243630TL	\$1,219
	24 x 42 x 30	21.2 / 131	26-RL244230TL	\$1,320
	26 x 36 x 30	19.8 / 126	26-RL263630TL	\$1,255
	26 x 42 x 30	22.9 / 134	26-RL264230TL	\$1,360
	30 x 36 x 30	22.6 / 133	26-RL303630TL	\$1,395
30 x 42 x 30	26.1 / 142	26-RL304230TL	\$1,511	

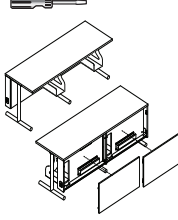
	D x W x H (in.)	ft ³ / lbs	Model	List Price
T legs 	Three leg bases - Double laminate modesty			
	• Available with casters (Specify "C" and add \$150)			
	24 x 72 x 30	35.7 / 279	26-RL247230TL	\$2,156
	26 x 72 x 30	38.4 / 283	26-RL267230TL	\$2,221
	30 x 72 x 30	43.9 / 292	26-RL307230TL	\$2,466

Classroom Training Tables

How To Order

1. Select model number and choose leg style

Ex: 25-RT247230AL

2. Select finish color for legs and laminate color for work surface (see page 59-60)

Ex: PBL 044
base work surface

OPTIONS

3. Casters or height-adjustable legs (Arched or T-legs only)

For casters, add **-C** to the model number and add \$50 list, per leg.

Ex: 25-RT247230AL-C

For height-adjustable legs, add **-H** to the model number and add \$140 list, per leg.

Ex: 25-RT247230AL-H

4. Select essential accessory options (see page 54)

Ex: RWG01 (Round wire grommet)

Model Number Structure

25	-	RT	247230	AL
27 - Double table with stiffener bar instead of middle leg base		Top Shape RT-Rectangle	Size D x W x H	Leg AL - Arched leg TL - T-leg SL - Straight leg AC - Arched leg w/ casters* TC - T-leg w/ casters* <small>*Nesting tables only</small>

Leg Base Styles & Options

- 2-inch diameter metal legs, 16 gauge metal
- Leg mounting plates 1/4" thick
- Powder coated paint

Styles



Options



Rectangle Tables

D x W x H (in.)	ft ³ / lbs	Model	List Price
Arch Legs			
Two leg bases.			
18 x 36 x 30	5.5 / 50	25-RT183630AL	\$726
18 x 42 x 30	5.7 / 55	25-RT184230AL	\$743
18 x 48 x 30	6.1 / 59	25-RT184830AL	\$774
18 x 60 x 30	6.6 / 86	25-RT186030AL	\$894
24 x 36 x 30	6.0 / 61	25-RT243630AL	\$764
24 x 42 x 30	6.3 / 65	25-RT244230AL	\$786
24 x 48 x 30	6.7 / 71	25-RT244830AL	\$802
24 x 60 x 30	7.4 / 102	25-RT246030AL	\$952
30 x 36 x 30	6.5 / 68	25-RT303630AL	\$787
30 x 42 x 30	6.9 / 74	25-RT304230AL	\$812
30 x 48 x 30	7.5 / 80	25-RT304830AL	\$844
30 x 60 x 30	8.3 / 114	25-RT306030AL	\$1,030
36 x 42 x 30	7.6 / 97	25-RT364230AL	\$863
36 x 48 x 30	8.1 / 104	25-RT364830AL	\$897
36 x 60 x 30	9.2 / 136	25-RT366030AL	\$1,087



(-C, 2 legs)

3rd leg base is replaced with stiffener bars

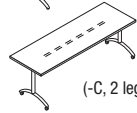
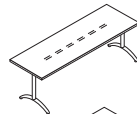

(-C, 2 legs)

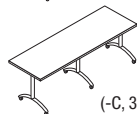

(-C, 3 legs)

D x W x H (in.)	ft ³ / lbs	Model	List Price
Double table w/ 2 leg bases & stiffener bars in middle for support.			
18 x 72 x 30	8.2 / 93	27-RT187230AL	\$960
18 x 84 x 30	8.8 / 101	27-RT188430AL	\$1,180
24 x 72 x 30	9.2 / 111	27-RT247230AL	\$1,038
24 x 84 x 30	10.0 / 120	27-RT248430AL	\$1,247
30 x 72 x 30	10.3 / 126	27-RT307230AL	\$1,097
30 x 84 x 30	11.2 / 138	27-RT308430AL	\$1,413
36 x 72 x 30	11.3 / 151	27-RT367230AL	\$1,232
36 x 84 x 30	12.4 / 165	27-RT368430AL	\$1,502

D x W x H (in.)	ft ³ / lbs	Model	List Price
Three leg bases.			
18 x 72 x 30	8.2 / 93	25-RT187230AL	\$960
18 x 84 x 30	8.8 / 101	25-RT188430AL	\$1,180
18 x 96 x 30	9.4 / 107	25-RT189630AL	\$1,485
24 x 72 x 30	9.2 / 111	25-RT247230AL	\$1,038
24 x 84 x 30	10.0 / 120	25-RT248430AL	\$1,247
24 x 96 x 30	10.7 / 130	25-RT249630AL	\$1,555
30 x 72 x 30	10.3 / 126	25-RT307230AL	\$1,097
30 x 84 x 30	11.2 / 138	25-RT308430AL	\$1,413
30 x 96 x 30	12.1 / 150	25-RT309630AL	\$1,725
36 x 72 x 30	11.3 / 151	25-RT367230AL	\$1,232
36 x 84 x 30	12.4 / 165	25-RT368430AL	\$1,502
36 x 96 x 30	13.2 / 181	25-RT369630AL	\$1,811

D x W x H (in.)	ft ³ / lbs	Model	List Price
T Legs			
Two leg bases.			
18 x 36 x 30	5.5 / 50	25-RT183630TL	\$565
18 x 42 x 30	5.7 / 55	25-RT184230TL	\$577
18 x 48 x 30	6.4 / 59	25-RT184830TL	\$588
18 x 60 x 30	6.6 / 86	25-RT186030TL	\$641
24 x 36 x 30	6.0 / 61	25-RT243630TL	\$597
24 x 42 x 30	6.3 / 65	25-RT244230TL	\$610
24 x 48 x 30	6.7 / 71	25-RT244830TL	\$624
24 x 60 x 30	7.4 / 102	25-RT246030TL	\$679
30 x 36 x 30	6.5 / 68	25-RT303630TL	\$646
30 x 42 x 30	6.9 / 74	25-RT304230TL	\$666
30 x 48 x 30	7.5 / 80	25-RT304830TL	\$700
30 x 60 x 30	8.3 / 114	25-RT306030TL	\$773
36 x 42 x 30	7.6 / 97	25-RT364230TL	\$724
36 x 48 x 30	8.1 / 104	25-RT364830TL	\$752
36 x 60 x 30	9.2 / 136	25-RT366030TL	\$846



(-C, 2 legs)

Rectangle Tables

D x W x H (in.) ft³ / lbs Model List Price

T-Legs

Double table w/ 2 leg bases & stiffener bars in middle for support.

18 x 72 x 30	8.2 / 93	27-RT187230TL	\$689
18 x 84 x 30	8.8 / 101	27-RT188430TL	\$880
24 x 72 x 30	9.2 / 111	27-RT247230TL	\$824
24 x 84 x 30	10.0 / 120	27-RT248430TL	\$973
30 x 72 x 30	10.3 / 126	27-RT307230TL	\$841
30 x 84 x 30	11.2 / 138	27-RT308430TL	\$1,125
36 x 72 x 30	11.3 / 151	27-RT367230TL	\$961
36 x 84 x 30	12.4 / 165	27-RT368430TL	\$1,206

T Legs

Three leg bases.

18 x 72 x 30	8.2 / 93	25-RT187230TL	\$689
18 x 84 x 30	8.8 / 101	25-RT188430TL	\$880
18 x 96 x 30	9.4 / 107	25-RT189630TL	\$1,055
24 x 72 x 30	9.2 / 111	25-RT247230TL	\$824
24 x 84 x 30	10.0 / 120	25-RT248430TL	\$973
24 x 96 x 30	10.7 / 130	25-RT249630TL	\$1,191
30 x 72 x 30	10.3 / 126	25-RT307230TL	\$841
30 x 84 x 30	11.2 / 138	25-RT308430TL	\$1,125
30 x 96 x 30	12.1 / 150	25-RT309630TL	\$1,317
36 x 72 x 30	11.3 / 151	25-RT367230TL	\$961
36 x 84 x 30	12.4 / 165	25-RT368430TL	\$1,206
36 x 96 x 30	13.2 / 181	25-RT369630TL	\$1,399

Straight legs

Four legs

18 x 36 x 30	2.3 / 50	25-RT183630SL	\$565
18 x 42 x 30	2.5 / 55	25-RT184230SL	\$577
18 x 48 x 30	2.8 / 59	25-RT184830SL	\$588
18 x 60 x 30	3.3 / 86	25-RT186030SL	\$641
24 x 36 x 30	2.7 / 61	25-RT243630SL	\$597
24 x 42 x 30	3.1 / 65	25-RT244230SL	\$610
24 x 48 x 30	3.5 / 71	25-RT244830SL	\$624
24 x 60 x 30	4.2 / 102	25-RT246030SL	\$679
30 x 36 x 30	3.3 / 68	25-RT303630SL	\$646
30 x 42 x 30	3.7 / 74	25-RT304230SL	\$666
30 x 48 x 30	4.2 / 80	25-RT304830SL	\$700
30 x 60 x 30	5.1 / 114	25-RT306030SL	\$773
36 x 42 x 30	4.4 / 97	25-RT364230SL	\$724
36 x 48 x 30	4.9 / 104	25-RT364830SL	\$752
36 x 60 x 30	5.9 / 136	25-RT366030SL	\$846

Double table w/ 4 straight legs & stiffener bars in middle for support.

18 x 72 x 30	4.2 / 93	27-RT187230SL	\$689
18 x 84 x 30	4.7 / 101	27-RT188430SL	\$880
24 x 72 x 30	5.3 / 111	27-RT247230SL	\$824
24 x 84 x 30	5.9 / 120	27-RT248430SL	\$973
30 x 72 x 30	6.2 / 126	27-RT307230SL	\$841
30 x 84 x 30	7.2 / 138	27-RT308430SL	\$1,125
36 x 72 x 30	6.5 / 151	27-RT367230SL	\$961
36 x 84 x 30	8.4 / 165	27-RT368430SL	\$1,206

3rd leg base is replaced with stiffener bars

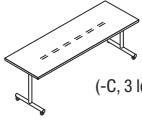
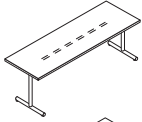

(-C, 3 legs)

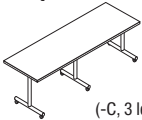
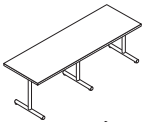

(-C, 3 legs)

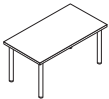

Set of middle legs are replaced with stiffener bars

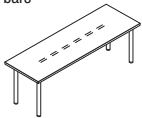

Rectangle Tables

D x W x H (in.) ft³ / lbs Model List Price

Straight Legs

Six legs

18 x 72 x 30	4.2 / 93	25-RT187230SL	\$745
18 x 84 x 30	4.7 / 101	25-RT188430SL	\$951
18 x 96 x 30	5.3 / 107	25-RT189630SL	\$1,140
24 x 72 x 30	5.3 / 111	25-RT247230SL	\$890
24 x 84 x 30	5.9 / 120	25-RT248430SL	\$1,051
24 x 96 x 30	6.7 / 130	25-RT249630SL	\$1,287
30 x 72 x 30	6.2 / 126	25-RT307230SL	\$909
30 x 84 x 30	7.2 / 138	25-RT308430SL	\$1,215
30 x 96 x 30	8.1 / 150	25-RT309630SL	\$1,423
36 x 72 x 30	6.5 / 151	25-RT367230SL	\$1,038
36 x 84 x 30	8.4 / 165	25-RT368430SL	\$1,303
36 x 96 x 30	9.4 / 181	25-RT369630SL	\$1,511

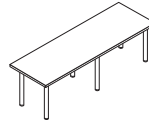

Nesting Tables

Stiffeners included on tables 60" wide and up.

Table with arched legs & folding top

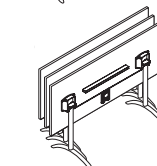
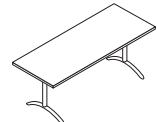
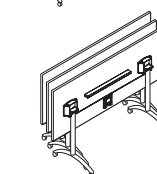
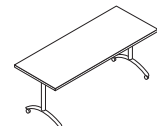

Table with arched legs, folding top & casters



18 x 36 x 30	5.4 / 50	25-NT183630AL	\$938
18 x 42 x 30	5.7 / 55	25-NT184230AL	\$1,002
18 x 48 x 30	6.1 / 59	25-NT184830AL	\$1,031
18 x 60 x 30	6.6 / 65	25-NT186030AL	\$1,147
18 x 72 x 30	7.1 / 72	25-NT187230AL	\$1,186
18 x 84 x 30	7.7 / 80	25-NT188430AL	\$1,238
18 x 96 x 30	8.2 / 86	25-NT189630AL	\$1,272
24 x 36 x 30	6.1 / 61	25-NT243630AL	\$958
24 x 42 x 30	6.3 / 65	25-NT244230AL	\$1,009
24 x 48 x 30	6.7 / 71	25-NT244830AL	\$1,088
24 x 60 x 30	7.5 / 80	25-NT246030AL	\$1,215
24 x 72 x 30	8.2 / 89	25-NT247230AL	\$1,242
24 x 84 x 30	8.9 / 98	25-NT248430AL	\$1,330
24 x 96 x 30	9.6 / 108	25-NT249630AL	\$1,402
30 x 36 x 30	6.5 / 68	25-NT303630AL	\$990
30 x 42 x 30	6.9 / 74	25-NT304230AL	\$1,058
30 x 48 x 30	7.4 / 80	25-NT304830AL	\$1,172
30 x 60 x 30	8.3 / 91	25-NT306030AL	\$1,314
30 x 72 x 30	9.2 / 103	25-NT307230AL	\$1,367
30 x 84 x 30	10.1 / 115	25-NT308430AL	\$1,383
30 x 96 x 30	10.9 / 127	25-NT309630AL	\$1,480
18 x 36 x 30	5.4 / 52	25-NT183630AC	\$1,014
18 x 42 x 30	5.7 / 57	25-NT184230AC	\$1,072
18 x 48 x 30	6.1 / 61	25-NT184830AC	\$1,144
18 x 60 x 30	6.6 / 67	25-NT186030AC	\$1,260
18 x 72 x 30	7.1 / 74	25-NT187230AC	\$1,300
18 x 84 x 30	7.7 / 82	25-NT188430AC	\$1,350
18 x 96 x 30	8.2 / 88	25-NT189630AC	\$1,385
24 x 36 x 30	6.1 / 63	25-NT243630AC	\$1,051
24 x 42 x 30	6.3 / 67	25-NT244230AC	\$1,113
24 x 48 x 30	6.7 / 73	25-NT244830AC	\$1,199
24 x 60 x 30	7.5 / 82	25-NT246030AC	\$1,327
24 x 72 x 30	8.2 / 91	25-NT247230AC	\$1,350
24 x 84 x 30	8.9 / 100	25-NT248430AC	\$1,442
24 x 96 x 30	9.6 / 110	25-NT249630AC	\$1,511
30 x 36 x 30	6.5 / 70	25-NT303630AC	\$1,101
30 x 42 x 30	6.9 / 76	25-NT304230AC	\$1,170
30 x 48 x 30	7.4 / 82	25-NT304830AC	\$1,284
30 x 60 x 30	8.3 / 93	25-NT306030AC	\$1,330
30 x 72 x 30	9.2 / 105	25-NT307230AC	\$1,478
30 x 84 x 30	10.1 / 117	25-NT308430AC	\$1,494
30 x 96 x 30	10.9 / 129	25-NT309630AC	\$1,591

Flat PVC edge banding
Thermofused laminate top

Classroom Training Tables

Nesting Tables

Table with T-legs
& folding top

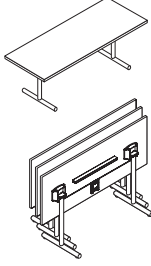

D x W x H (in.)	ft ³ / lbs	Model	List Price
18 x 36 x 30	5.4 / 50	25-NT183630TL	\$754
18 x 42 x 30	5.7 / 55	25-NT184230TL	\$804
18 x 48 x 30	6.1 / 59	25-NT184830TL	\$855
18 x 60 x 30	6.6 / 65	25-NT186030TL	\$1,010
18 x 72 x 30	7.1 / 72	25-NT187230TL	\$1,050
18 x 84 x 30	7.7 / 80	25-NT188430TL	\$1,093
18 x 96 x 30	8.2 / 86	25-NT189630TL	\$1,131
24 x 36 x 30	6.1 / 61	25-NT243630TL	\$806
24 x 42 x 30	6.3 / 65	25-NT244230TL	\$856
24 x 48 x 30	6.7 / 71	25-NT244830TL	\$908
24 x 60 x 30	7.5 / 80	25-NT246030TL	\$1,072
24 x 72 x 30	8.2 / 89	25-NT247230TL	\$1,096
24 x 84 x 30	8.9 / 98	25-NT248430TL	\$1,180
24 x 96 x 30	9.6 / 108	25-NT249630TL	\$1,247
30 x 36 x 30	6.5 / 68	25-NT303630TL	\$866
30 x 42 x 30	6.9 / 74	25-NT304230TL	\$912
30 x 48 x 30	7.4 / 80	25-NT304830TL	\$961
30 x 60 x 30	8.3 / 91	25-NT306030TL	\$1,160
30 x 72 x 30	9.2 / 103	25-NT307230TL	\$1,212
30 x 84 x 30	10.1 / 115	25-NT308430TL	\$1,228
30 x 96 x 30	10.9 / 127	25-NT309630TL	\$1,315

Table with T-legs,
folding top &
casters

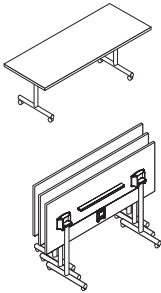

18 x 36 x 30	5.4 / 52	25-NT183630TC	\$866
18 x 42 x 30	5.7 / 57	25-NT184230TC	\$917
18 x 48 x 30	6.1 / 61	25-NT184830TC	\$967
18 x 60 x 30	6.6 / 67	25-NT186030TC	\$1,124
18 x 72 x 30	7.1 / 74	25-NT187230TC	\$1,161
18 x 84 x 30	7.7 / 82	25-NT188430TC	\$1,206
18 x 96 x 30	8.2 / 88	25-NT189630TC	\$1,244
24 x 36 x 30	6.1 / 63	25-NT243630TC	\$919
24 x 42 x 30	6.3 / 67	25-NT244230TC	\$969
24 x 48 x 30	6.7 / 73	25-NT244830TC	\$1,020
24 x 60 x 30	7.5 / 82	25-NT246030TC	\$1,183
24 x 72 x 30	8.2 / 91	25-NT247230TC	\$1,250
24 x 84 x 30	8.9 / 100	25-NT248430TC	\$1,291
24 x 96 x 30	9.6 / 110	25-NT249630TC	\$1,360
30 x 36 x 30	6.5 / 70	25-NT303630TC	\$975
30 x 42 x 30	6.9 / 76	25-NT304230TC	\$1,022
30 x 48 x 30	7.4 / 82	25-NT304830TC	\$1,074
30 x 60 x 30	8.3 / 93	25-NT306030TC	\$1,272
30 x 72 x 30	9.2 / 105	25-NT307230TC	\$1,325
30 x 84 x 30	10.1 / 117	25-NT308430TC	\$1,340
30 x 96 x 30	10.9 / 129	25-NT309630TC	\$1,426

Quarter Round Tables

Quarter round
tables

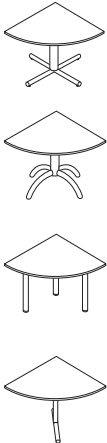

Height-adjustable leg not available.

Straight X-leg			
24 x 24 x 30	17.1 / 32	25-QR242430XS	\$650
30 x 30 x 30	17.9 / 47	25-QR303030XS	\$765
36 x 36 x 30	18.9 / 62	25-QR363630XS	\$850
Arched X-leg			
24 x 24 x 30	17.1 / 32	25-QR242430XA	\$868
30 x 30 x 30	17.9 / 47	25-QR303030XA	\$949
36 x 36 x 30	18.9 / 62	25-QR363630XA	\$1,042
Straight leg			
24 x 24 x 30	1.1 / 32	25-QR242430SL	\$868
30 x 30 x 30	2.9 / 47	25-QR303030SL	\$949
36 x 36 x 30	3.8 / 62	25-QR363630SL	\$1,042
T-leg for stability only. Designed to attach to other units on both sides.			
30 x 30 x 30	6.1 / 44	25-QR303030TL	\$764
36 x 36 x 30	7.1 / 59	25-QR363630TL	\$850

Round Tables

Round tables



Square tables

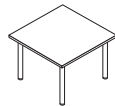
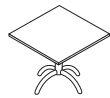

D x W x H (in.) ft³ / lbs Model List Price

Height-adjustable leg not available.

Straight X-leg

30 x 30 x 30	17.9 / 46	25-FR303030XS	\$602
36 x 36 x 30	18.9 / 67	25-FR363630XS	\$693
42 x 42 x 30	20.1 / 85	25-FR424230XS	\$935
48 x 48 x 30	21.4 / 102	25-FR484830XS	\$1,028

Arched X-leg

30 x 30 x 30	17.9 / 46	25-FR303030XA	\$772
36 x 36 x 30	18.9 / 67	25-FR363630XA	\$847
42 x 42 x 30	20.1 / 85	25-FR424230XA	\$1,099
48 x 48 x 30	21.4 / 102	25-FR484830XA	\$1,140

Straight legs

30 x 30 x 30	2.9 / 46	25-FR303030SL	\$772
36 x 36 x 30	3.8 / 67	25-FR363630SL	\$847
42 x 42 x 30	4.9 / 85	25-FR424230SL	\$1,099
48 x 48 x 30	6.3 / 102	25-FR484830SL	\$1,140

Square Tables

Height-adjustable leg not available.

Straight X-leg

30 x 30 x 30	17.9 / 46	25-SQ303030XS	\$580
36 x 36 x 30	18.9 / 67	25-SQ363630XS	\$681
42 x 42 x 30	20.1 / 85	25-SQ424230XS	\$917
48 x 48 x 30	21.4 / 102	25-SQ484830XS	\$981

Arched X-leg

30 x 30 x 30	17.9 / 46	25-SQ303030XA	\$752
36 x 36 x 30	18.9 / 67	25-SQ363630XA	\$823
42 x 42 x 30	20.1 / 85	25-SQ424230XA	\$1,031
48 x 48 x 30	21.4 / 102	25-SQ484830XA	\$1,084

Straight leg

30 x 30 x 30	2.9 / 46	25-SQ303030SL	\$752
36 x 36 x 30	3.8 / 67	25-SQ363630SL	\$823
42 x 42 x 30	4.9 / 85	25-SQ424230SL	\$1,031
48 x 48 x 30	6.3 / 102	25-SQ484830SL	\$1,084

Factory Installed Keyboard Options Only for Tables

Factory Installed
Nova Keyboard

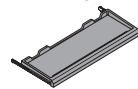

Keyboard length to fit casegoods ordered

22" - 34" wide	13	NK	\$123
----------------	----	----	-------

Factory Installed
Center Mount
Articulating Keyboard
Mechanism & Tray

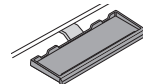



Keyboard length to fit casegoods ordered



28", 30", 34" wide	15	CK	\$256
--------------------	----	----	-------

1. Model number
2. Finish color for legs and laminate color for work surface.
3. Optional - Select essential accessory options.

Options/Accessories



	D x W x H (in.)	ft ³ / lbs	Model	List Price
18° bridge 	18 x 18 x 1 1/8	1.0 / 4	25-WG18180118	\$219
	24 x 24 x 1 1/8	1.6 / 10	25-WG24240118	\$236
	30 x 30 x 1 1/8	2.4 / 25	25-WG30300118	\$243
	36 x 36 x 1 1/8	3.4 / 32	25-WG36360118	\$259

30° bridge 	18 x 18 x 1 1/8	1.0 / 4	25-WG18180130	\$219
	24 x 24 x 1 1/8	1.6 / 10	25-WG24240130	\$236
	30 x 30 x 1 1/8	2.4 / 25	25-WG30300130	\$243
	36 x 36 x 1 1/8	3.4 / 32	25-WG36360130	\$259

45° bridge  	18 x 18 x 1 1/8	1.0 / 4	25-WG18180145	\$219
	24 x 24 x 1 1/8	1.6 / 10	25-WG24240145	\$236
	30 x 30 x 1 1/8	2.4 / 25	25-WG30300145	\$243

Leg is for stability only. Designed to attach to other units on both sides.

36 x 36 x 1 1/8	7.1 / 59	25-WG36360145	\$529
-----------------	----------	---------------	-------

60° bridge  	18 x 18 x 1 1/8	1.4 / 4	25-WG18180160	\$219
	24 x 24 x 1 1/8	2.1 / 10	25-WG24240160	\$236

Leg is for stability only. Designed to attach to other units on both sides.

30 x 30 x 1 1/8	6.1 / 44	25-WG30300160	\$513
36 x 36 x 1 1/8	7.1 / 59	25-WG36360160	\$529

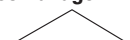
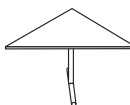
90° bridge  	18 x 18 x 1 1/8	1.4 / 4	25-WG18180190	\$219
	24 x 24 x 1 1/8	2.1 / 10	25-WG24240190	\$236

Leg is for stability only. Designed to attach to other units on both sides.

30 x 30 x 1 1/8	6.1 / 44	25-WG30300190	\$513
-----------------	----------	---------------	-------

Casters - Locking



When adding casters, the total height will not change.

Set of 2 required per leg.

2 5/8 x 1 3/4 x 3 1/4	-C	\$50 per leg
-----------------------	----	--------------

Height-adjustable legs

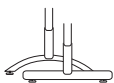

Adjustable height from 27"-37".

-H	\$140 per leg
----	---------------

D x W x H (in.)	ft ³ / lbs	Model	List Price
-----------------	-----------------------	-------	------------

Stiffener

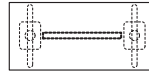

Use to prevent sagging of top. Standard color is black.

01 x 48 x 02	-- / 1	25-ST014802	\$98
01 x 60 x 02	-- / 1	25-ST016002	\$98
01 x 72 x 02	-- / 2	25-ST017202	\$125
01 x 84 x 02	-- / 3	25-ST018402	\$135
01 x 96 x 02	-- / 4	25-ST019602	\$157

Quick connector



Use when chaining two or more tables. Standard color is black.

03 x 06	-- / .5	25-QC060600	\$47
---------	---------	-------------	------

Modesty Panels

Laminate modesty panels

Table not included

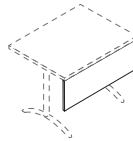

Specify a base color.

Single modesty

01 x 36 x 12	.25 / 8	25-SM013612	\$174
01 x 42 x 12	.3 / 9	25-SM014212	\$184
01 x 48 x 12	.3 / 10	25-SM014812	\$195
01 x 60 x 12	.5 / 13	25-SM016012	\$208

01 x 36 x 22	.45 / 14	25-SM013622	\$205
01 x 42 x 22	.5 / 16	25-SM014222	\$208
01 x 48 x 22	.6 / 18	25-SM014822	\$218
01 x 60 x 22	.75 / 23	25-SM016022	\$232

Double modesty

01 x 72 x 12	.5 / 15	25-SM017212	\$347
01 x 84 x 12	.6 / 18	25-SM018412	\$364
01 x 96 x 12	.75 / 20	25-SM019612	\$387

01 x 72 x 22	1 / 28	25-SM017222	\$407
01 x 84 x 22	1 / 32	25-SM018422	\$413
01 x 96 x 22	1.2 / 37	25-SM019622	\$432

Perforated metal modesty panels

Table not included

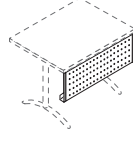

Specify a metal color.

Single modesty

01 x 36 x 12	.25 / 8	25-PM013612	\$378
01 x 42 x 12	.3 / 9	25-PM014212	\$409
01 x 48 x 12	.3 / 10	25-PM014812	\$447
01 x 60 x 12	.5 / 13	25-PM016012	\$496

01 x 36 x 22	.45 / 14	25-PM013622	\$445
01 x 42 x 22	.5 / 17	25-PM014222	\$463
01 x 48 x 22	.6 / 19	25-PM014822	\$496
01 x 60 x 22	.75 / 24	25-PM016022	\$566

Double modesty

01 x 72 x 12	.5 / 16	25-PM017212	\$755
01 x 84 x 12	.6 / 18	25-PM018412	\$814
01 x 96 x 12	.75 / 21	25-PM019612	\$889

01 x 72 x 22	1 / 29	25-PM017222	\$887
01 x 84 x 22	1 / 33	25-PM018422	\$922

Flat PVC edge banding
Thermofused laminate top
Metal or laminate bases

Classroom Training

Tables with Total Access iMod Accessories

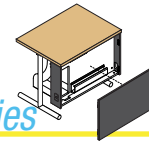

ASSEMBLY REQUIRED

How To Order

1. Select model number

Ex: 26-RM303630TL

• To specify an **ADA Height** unit, change height from 30 to **32** in model number and add \$196 for single table or \$293 for double table. Ex: 26-RM303632TL

2. Select metal color for legs and laminate color for work surface (see page 59-60)

Ex: PBL 044

Base Worksurface

3. Select metal color for metal iMod modesty or laminate base color for laminate iMod modesty

Ex: PSL (Polished silver metal color for metal modesty)

227 (Fashion Grey laminate color for laminate modesty)

OPTIONS

4. Casters or height-adjustable legs:

For casters, add **-C** to the model number and add \$50 list, per leg.

Ex: 26-RM303630TL-C

For height-adjustable legs, add **-H** to the model number and add \$140 list, per leg.

Ex: 26-RM303630TL-H

5. Select visual display options (see page 24)

Ex: TE0724NK (The Trolley E with Nova keyboard drawer)

6. Select essential options (see page 54)

Ex: RWG01 (Round wire grommet)

7. Select end caps for iMod table with metal modesty

Ex: 26-ENDCAP22 (End caps)

Specify metal color for end caps

Ex: PSL (Polished silver metal color)

Miscellaneous

End cap For metal iMod

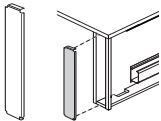

Fits on right or left open end of metal iMod compartment. Specify metal color.

D x W x H (in.)	ft ³ / lbs	Model	List Price
01 x 03 x 20	0.1 / 3	26-ENDCAP22	\$92

Extra ADA end cap For metal iMod

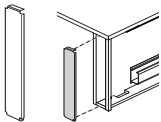

To be used with ADA height units that are intended for stand-alone use only (i.e. Units that are not used as part of a row). Fits on right or left end of metal iMod compartment. Specify metal color. Note: Only one (1) Extra ADA End Cap per unit is needed as ADA height units ship with one ADA End Cap included

D x W x H (in.)	ft ³ / lbs	Model	List Price
01 x 03 x 24	0.1 / 3	26-ENDCAP24	\$99

Casters



When adding casters, the total height will not change.

Set of 2 required per leg. All locking.

Size	Model	List Price
2 5/8 x 1 3/4 x 3 1/4	-C	\$50 per leg

Height-adjustable legs



Adjustable height from 27"-37".

Model	List Price
-H	\$140 per leg

Privacy Panels for Single Table



D x W x H (in.)	ft ³ / lbs	Model	List Price
-----------------	-----------------------	-------	------------

For factory prep, must specify "PP" on table model number. Specify base color only. 6" radius on front. Field installed.

24 x 36 x 15	1.5 / 37	26-PP243615	\$370
24 x 42 x 15	1.7 / 40	26-PP244215	\$405

26 x 36 x 15	1.5 / 38	26-PP263615	\$387
26 x 42 x 15	1.7 / 41	26-PP264215	\$424

30 x 36 x 15	1.5 / 42	26-PP303615	\$407
30 x 42 x 15	1.7 / 44	26-PP304215	\$451

Privacy Panels for Double Table

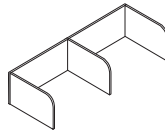

For factory prep, must specify "PP" on table model number. Specify base color only. 6" radius on front. Field installed.

24 x 71 x 15	1.8 / 51	26-PP247115	\$632
--------------	----------	-------------	-------

26 x 71 x 15	1.8 / 52	26-PP267115	\$651
--------------	----------	-------------	-------

30 x 71 x 15	1.8 / 55	26-PP307115	\$696
--------------	----------	-------------	-------

Rectangular Wire Grommet



Black plastic grommet cover is removable for easy wire management. If installed (available for work surface only): Please provide sketch to indicate placement location

1 7/8 x 3 1/4 x 1 1/4 (cutout dimensions)	WG1080	\$72
---	--------	------

If Sold Separately (not part of base model):

1 7/8 x 3 1/4 x 1 1/4 (cutout dimensions)	AC-WG1080	\$37
---	-----------	------

For other grommet options, see page 55.

Locking option

For locking modesty cover(s)

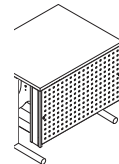

Specify "L" and add \$152 for a single table and \$303 for a double table.

L	\$152 / Single \$303 / Double
---	----------------------------------

ADA lift option

Hydraulic lift
2 1/2" travel

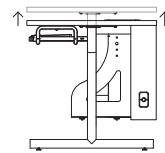

Change model number to 26-AM... / 26-AL...

Electric Hydraulic lift stored within legs, activated with buttons mounted beneath worksurface. Available on single units only.

See "How to Order" on pg. 16 **\$4,277**

Factory Installed Keyboard Options (Only ordered when NO Visual Display Options ordered)

Factory Installed Nova Keyboard

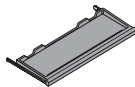

Keyboard length to fit casegoods ordered

22" - 34" wide	13	NK	\$123
----------------	----	----	-------

Factory Installed Center Mount Articulating Keyboard Mechanism & Tray

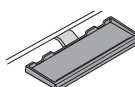

Keyboard length to fit casegoods ordered

28", 30", 34" wide	15	CK	\$256
--------------------	----	----	-------

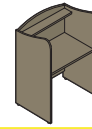

Features, Benefits and Solutions

- Solutions for library and learning resource environments
- Visual Display Options available
- Work surface thickness: 1"
- Standard edge detail: 2mm Flat PVC
- Matching edge banding colors
- Wire management system and power strip optional
- Manufactured with recycled post-industrial materials

How To Order

1. Select model number

Ex: 65-SC303635CS (single sided study carrel, starter)

2. Select laminate base and work surface color (see page 59)

Ex: 008 C24
Base Worksurface

OPTIONS

3. Select visual display options (see page 24)

Ex: TE0724NK (The Trolley E with Nova keyboard drawer)

4. Select essential accessory options (see page 54)

Ex: RWG01 (Round wire grommet)

Model Number Structure



65-SC303635CS

65
Series

SC
Type

303635
Size

CS
Placement
CS-Starter
CA-Add-on

SC-Single-sided carrel D x W x H
DC-Double-sided carrel

Work Surface Edge Detail

Standard
Flat PVC edge 2mm
1" thick



Study Carrels

Wire opening on top. Wire access on side panel of add-on carrels only. If a Visual Display Option is specified, a CPU shelf, wire management channel, and power strip will be added. Rectangular black plastic grommet in work surface. Work surface height: 30". Work surface depth: 28".

Single-sided carrels 35" H

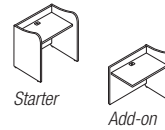

D x W x H (in.)	ft ³ / lbs	Model	List Price
Starter			
30 x 36 x 35	3.5 / 126	65-SC303635CS	\$884
Add-on			
30 x 35 x 35	2.8 / 99	65-SC303535CA	\$707

Single-sided carrels 53" H

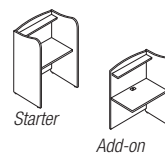

8" D fixed accessory shelf. Clearance 15-3/8".			
D x W x H (in.)	ft ³ / lbs	Model	List Price
Starter			
30 x 36 x 53	4.7 / 167	65-SC303653CS	\$1237
Add-on			
30 x 35 x 53	3.56 / 126	65-SC303553CA	\$970

Double-sided carrels 35" H

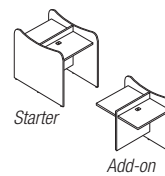

Starter			
59 x 36 x 35	5.4 / 208	65-DC593635CS	\$1,325
Add-on			
59 x 35 x 35	4.3 / 155	65-DC593535CA	\$1,020

Double-sided carrels 53" H

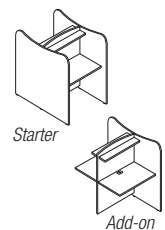

8" D fixed accessory shelf. Clearance 15-3/8".			
D x W x H (in.)	ft ³ / lbs	Model	List Price
Starter			
59 x 36 x 53	9.1 / 276	65-DC593653CS	\$2,029
Add-on			
59 x 35 x 53	7.3 / 196	65-DC593553CA	\$1,540

ADA Bracket Kit



Metal bracket and hardware to raise the surface of any carrel from 30" to 32". Package of six. Order one kit per surface.

01 x 01 x 04	.3 / 1	65-KT010104AD	\$132
--------------	--------	----------------------	--------------

Factory Installed Keyboard Options (Only ordered when NO Visual Display Options ordered)

Factory Installed Nova Keyboard

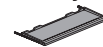

Keyboard length to fit casegoods ordered

22" - 34" wide	13	NK	\$123
----------------	----	-----------	--------------

Factory Installed Center Mount Articulating Keyboard Mechanism & Tray

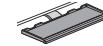

Keyboard length to fit casegoods ordered

28", 30", 34" wide	15	CK	\$256
--------------------	----	-----------	--------------

Visual Display Options

Single monitor workstations require one (1) visual display option. Double monitor workstations require two (2) visual display options.

For Tables with iMod & Study Carrels

Factory installed keyboard-only options available on pg. 22 for Tables with iMod, pg. 23 for Study Carrels

- For details and installation specifications, refer to pages 47-51
- For CRT applications, please contact Customer Support: 1-800-730-6682

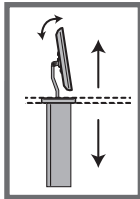

The Trolley™

Trolley does not come installed in any unit.
26" min. worksurface depth required for Trolley with Center Mount Articulating Keyboard Tray
 Maximum distance from center of wall mount VESA plate to bottom of monitor is 6 3/4" (171mm)

The Trolley™ EXL

Maximum Dimensions for Widescreen:

2 1/2" D x 22 7/8" W x 14 1/2" H
 up to 24" diagonal widescreen
36" min. worksurface width

- Low voltage motor to lift & lower monitor
- Provides vertical tilt adjustment in "up" position
- Durable metal enclosure under desktop
- Wire management system and power strip included

The Trolley™ E

Maximum Dimensions for Widescreen:

2 1/2" D x 18 7/8" W x 14 1/2" H
 up to 21" (diagonal) or
 20" (widescreen)

Model Wt.

List Price

Qty 2 required for Double Workstations/Tables

With Nova Keyboard Drawer

Nova Keyboard Drawer installed in assembled units only.

TE0728NK	48	The Trolley EXL with Nova Keyboard drawer	\$1,775 ea.
TE0724NK	48	The Trolley E with Nova Keyboard drawer	\$1,339 ea.

International Customers: Trolleys include Universal Power Control Units, compatible with all power requirements inside and outside the U.S.

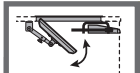

Downview™

18"D x 18"W viewport

Maximum Dimensions for Widescreen: 17"W x 14 1/2"H
 up to 19" diagonal
26" min. work surface depth

16"D x 21"W viewport (Widescreen)

Maximum Dimensions for Widescreen: 19 1/2"W x 12 1/2" H
 up to 21" widescreen
24" min. work surface depth

21"D x 21"W viewport

Maximum Dimensions for Widescreen: 20 1/8"W x 19"H
 up to 21" diagonal
28-30" min. work surface depth

18"D x 21"W viewport (Widescreen)

Maximum Dimensions for Widescreen: 20 1/8"W x 14 1/2"H
 up to 21" widescreen
26" min. work surface depth

- Tinted, tempered glass viewport
- Keeps monitor under glass below work surface
- Wire management system and power strip included

21"D x 24"W viewport (Widescreen)

Maximum Dimensions for Widescreen: 22 1/2"W x 19"H
 up to 23" widescreen
30" min. work surface depth
36" min. work surface width

Model Wt.

List Price

Qty 2 required for Double Workstations/Tables

With Nova Keyboard Drawer

Downview & Nova Keyboard Drawer installed in assembled units only.

FPA1621NK	35	Includes 16"D x 21"W viewport, adjustable arm, and visor.	\$413 ea.
FPA1818NK	35	Includes 18"D x 18"W viewport, adjustable arm, and visor.	\$438 ea.
FPA1821NK	35	Includes 18"D x 21"W viewport, adjustable arm, and visor.	\$438 ea.
FPA2121NK	37	Includes 21"D x 21"W viewport, adjustable arm, and visor.	\$511 ea.
FPA2124NK	39	Includes 21"D x 24"W viewport, adjustable arm, and visor.	\$558 ea.

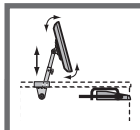

Surface Mount Arm

Surface Mount Arm does not come installed in any unit

Maximum Weight / Dimensions for Widescreen:

21 lbs. / Up to 24" diagonal widescreen

- Wire management system and power strip included

Model Wt.

List Price

Qty 2 required for Double Workstations/Tables

With Nova Keyboard Drawer

Nova Keyboard Drawer installed in assembled units only.

SMA0203NK	13		\$317 ea.
-----------	----	--	-----------

With Center Mount Articulating Keyboard Mechanism and Tray

Center Mount Keyboard Tray installed in assembled units only.

SMA0203CK	15		\$523 ea.
-----------	----	--	-----------

Hardwiring

How To Order Hardwire-Standard Workstation



1. Select a standard workstation, and add -W to the end of the model number
2. Complete room layout with workstations
3. Select power entry
4. Select jumper length
5. Select receptacle block
6. Select mounting bracket quantities for all receptacle blocks.

NOTE: Mounting brackets with receptacle block always located behind CPU storage.

Standard Features

4-wires, 2 circuits, 20 Amps each (Circuit 1 and 2 only)
 13-Duplex receptacles per circuit, 26-15 Amp Duplex receptacles per power infeed maximum
 Easy to specify
 Easy to install and reconfigure
 Requires less space
 UL Listed as a Manufactured Wiring System
 More economical than 8-Wire System

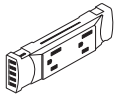
Electrical Components

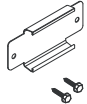
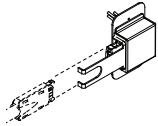
	D x W x H (in.)	Model	List Price
Receptacle Block 	Complete the model number by indicating its circuit number (Circuit 1 or Circuit 2). Example: a receptacle block for Circuit 1 would be model number BE41917-3-A-1-8B.		
		BE41917-3-A-1-8B	\$117
Mounting bracket sold separately. See below.			
Receptacle to Receptacle Block Connector 		BE41919-3	\$26
4-Way "H" Connector 		BE41921-3	\$43
Spring clip mounting bracket with Screws 		BE41955	\$8
Transition wall power plate <i>Power entry not included</i> 		BE42171-3-06	\$179

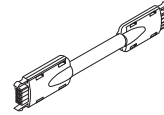
	D x W x H (in.)	Model	List Price
Female to Female Jumper 	6" W	BE41920-3-6	\$104
	12" W	BE41920-3-12	\$114
	18" W	BE41920-3-18	\$121
	22" W	BE41920-3-22	\$126
	24" W	BE41920-3-24	\$130
	30" W	BE41920-3-30	\$138
	36" W	BE41920-3-36	\$146
	42" W	BE41920-3-42	\$154
	48" W	BE41920-3-48	\$169
	54" W	BE41920-3-54	\$179
	60" W	BE41920-3-60	\$188
	66" W	BE41920-3-66	\$198
	72" W	BE41920-3-72	\$206
	78" W	BE41920-3-78	\$216
	84" W	BE41920-3-84	\$226
	90" W	BE41920-3-90	\$236
	96" W	BE41920-3-96	\$245
102" W	BE41920-3-102	\$253	
108" W	BE41920-3-108	\$264	
114" W	BE41920-3-114	\$274	
120" W	BE41920-3-120	\$281	
126" W	BE41920-3-126	\$292	
132" W	BE41920-3-132	\$301	
138" W	BE41920-3-138	\$310	
144" W	BE41920-3-144	\$320	

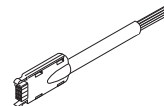
	D x W x H (in.)	Model	List Price
Power Entry 	36" W	BE41922-3-36	\$186
	42" W	BE41922-3-42	\$195
	48" W	BE41922-3-48	\$211
	54" W	BE41922-3-54	\$220
	60" W	BE41922-3-60	\$228
	66" W	BE41922-3-66	\$238
	72" W	BE41922-3-72	\$248
	78" W	BE41922-3-78	\$258
	84" W	BE41922-3-84	\$266
	90" W	BE41922-3-90	\$276
	96" W	BE41922-3-96	\$285
	102" W	BE41922-3-102	\$295
	108" W	BE41922-3-108	\$304
	114" W	BE41922-3-114	\$314
	120" W	BE41922-3-120	\$323
	126" W	BE41922-3-126	\$332
	132" W	BE41922-3-132	\$342
138" W	BE41922-3-138	\$351	
144" W	BE41922-3-144	\$360	

Sample Layout

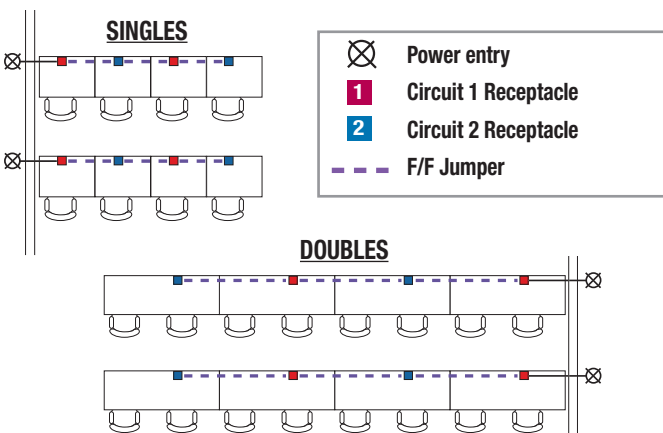

NOVALinked™ Components

NOVALinked™ is a networking system that provides complete control of NOVA's Trolley E monitor lifts in a classroom or training room setting. Utilizing a Crestron, Extron, AMX or other major brand controller, or an ISI component, instructors can raise or lower all of the Trolley monitor lifts in the classroom simultaneously.



LCI - Linking Control Interface
The LCI is required for all NOVALinked™ installations. One LCI is required to control each Trolley E monitor lift. It can be located in an inconspicuous location on each desk/table or within the total access iMod™ compartment (if available). 1-9/16" D x 4" W x 1-3/4" H

AC-LCI.....\$245



JCN - Junction
The JCN is a parallel 3 way splitter for the NovaLinked System. One Junction required per row. Designed for use only with the NovaLinked System.

1-9/16" D x 4" W x 1-3/4" H

AC-JCN3 (Three RJ45 ports).....\$184



CAT6 Patch Cable
Cat6 molded boot patch cable.

AC-CAT6-1 (1 Ft.).....	\$25
AC-CAT6-2 (2 Ft.).....	\$29
AC-CAT6-5 (5 Ft.).....	\$31
AC-CAT6-7 (7 Ft.).....	\$34
AC-CAT6-10 (10 Ft.).....	\$42
AC-CAT6-14 (14 Ft.).....	\$52

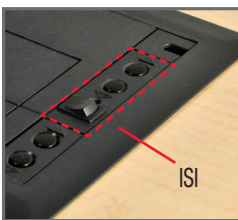

ISI - Independent Switching Interface
The ISI allows full control of the On/Off and Up/Down functions of the NOVALinked System without interfacing with a control system. The ISI Module is designed to be housed in the lectern-based Trolley E control panel.

AC-ISI (for Wired Systems).....\$413
AC-ISIRF (for Wireless RF Systems)\$413



CSIM - Control System Interface Module
The CSIM is required for "wired" NOVALinked™ installations. One CSIM is needed for every thirty LCI units/Trolley E monitor lifts. Includes a 24V = 1.67A, 40W MAX Power Supply with Cord. 1-9/16" D x 4-1/8" W x 2-15/16" H

AC-CSIM.....\$486

Components for Wireless NOVALinked™

The Wireless NOVALinked application eliminates the issue of running power from the lectern to the first row of desks, and from row to row.



TXM - Transmitter
The Transmitter allows wireless control of the Trolleys, and is housed in the lectern or any other location in the room. The Transmitter connects to the Controller or ISI, and each one has a unique frequency address. It sends separate commands for On, Off, Up and Down.

AC-TXM.....\$465



RCVR - Receiver
One Receiver required per row of desks, including the last row.

AC-RCVR.....\$465

NOTE: If not using a major brand controller, order ISI component for wireless systems (AC-ISIRF)

NOTE: Typically one CSIM is required for every 30 LCI units in the classroom. Each Trolley unit requires one LCI (even with the wireless configuration).

All NOVALinked™ components shown on this page.

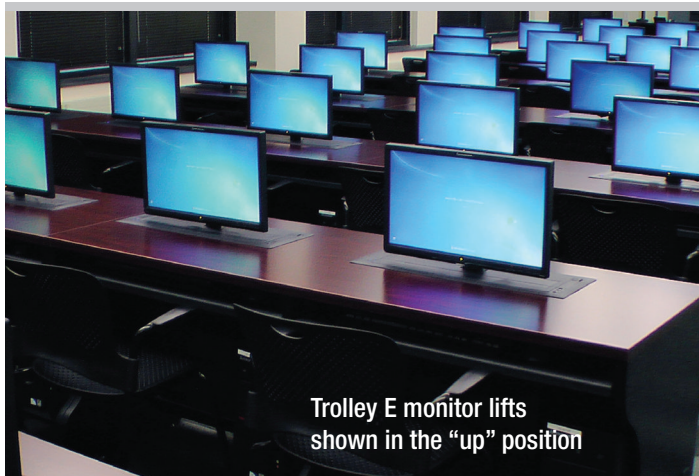

Trolley E monitor lifts shown in the "up" position



Trolley E monitor lifts shown in the "down" position



NOVA Linked™ Sample Layouts



 **RF Transmitter**, typically located on lectern (Qty 1)
Has a unique frequency.
AC-TXM



 **Receiver**
1 per row (Qty 4)
AC-RCVR



 **Independent Switching Interface**, typically located on lectern (Qty 1)
AC-ISIRF (for Wireless RF Systems)



 **Linking Control Interface**
1 per Trolley, except in Lectern when using a CSIM or Transmitter. If Lectern utilizes a Trolley with CSIM or Transmitter, then no need for an LCI.
(Qty 20)
AC-LCI



 **CAT6 Patch Cable**
1ft or 2ft cable needed to run from RCVR to the 1st LCI in each row
(Qty 4)
AC-CAT6-2



 5ft or 7ft cables needed to run from LCI to LCI in each row
(Qty 16)
AC-CAT6-5

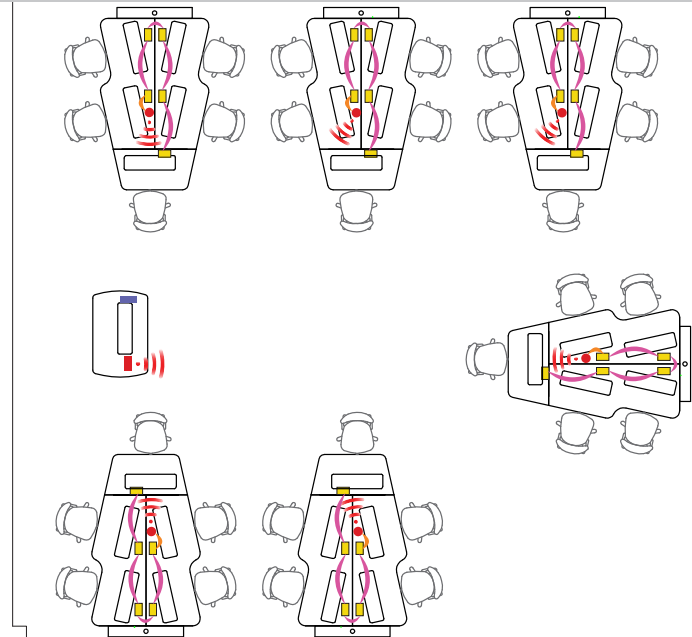
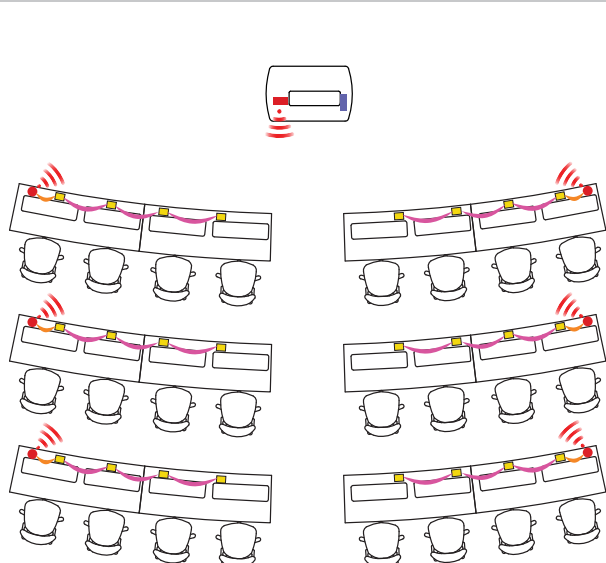
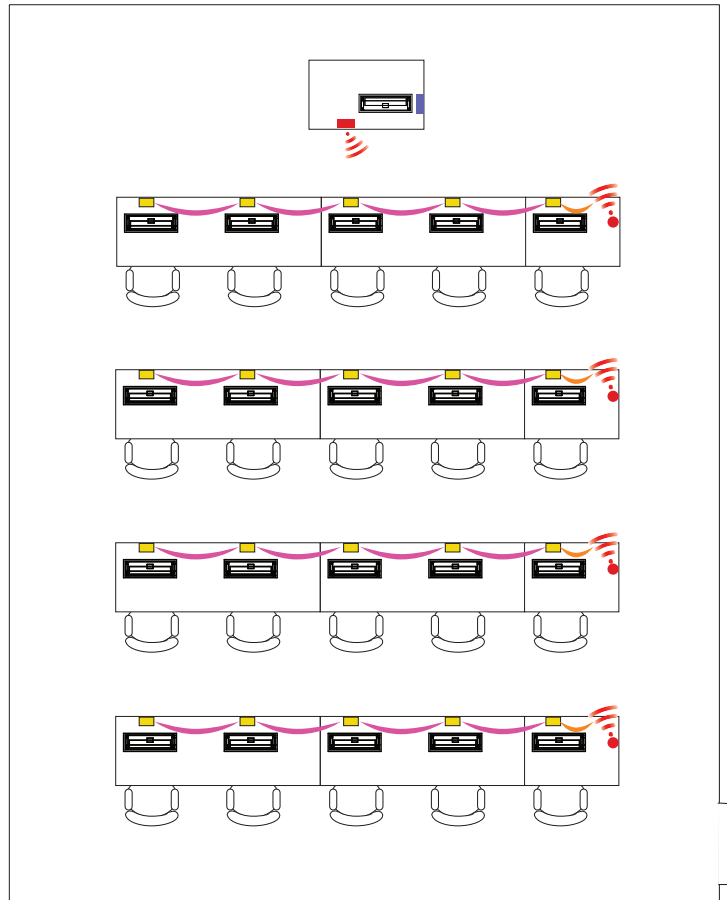

Audio/Visual Lecterns





Audio/Visual Lecterns

Modern designs provide a one-stop solution for integrating the latest technology into presentation lecterns.

- Accommodates latest A/V equipment
- Offers shelves and rack rail systems
- Some models available with Visual Display Options
- Hides wires and cables for a clutter-free look
- Heavy duty casters
- Removable modesty panel covers available in laminate or perforated metal
- Easy access to the back of equipment
- Provides security and prevents accidental damage to equipment

Presenting a complete solution.

How To Order

1. Select model number

Ex: 67-LS303641LM (Lectern 30x36x41 with pullout shelf and laminate modesty)

2. Select color laminate and work surface (see page 59)

If ordering perforated metal modesty, select metal color

Ex: 129 376 SLL
Base Worksurface Metal

3. Select door/drawer pull style and finish

Ex: CB (Cup pull with Black Matt finish)

OPTIONS

4. Select visual display options (see page 37)

Ex: TE0724NK (The Trolley E with Nova keyboard drawer)

5. Select essential accessory options (see page 54)

Ex: RWG01 (Round wire grommet)

Visual Display Options To order, see page 37

The Trolley™ Personal Monitor Arm System

Maximum dimensions for widescreen-

EXL: 2½" D x 22 7/8" W x 14½" H

E: 2½" D x 18 7/8" W x 14 1/2" H

NOTE: Maximum distance from center of wall mount VESA plate to bottom of monitor is 6 ¾" (171mm)

Downview™

Maximum dimensions for widescreen-

18x18 viewport: 17"W x 14½"H (432mm W x 368mm H)

21x21 viewport: 20⅞"W x 19" H (511mm W x 483mm H)

16x21 widescreen viewport: 19½"W x 12½" H (495mm W x 318mm H)

18x21 widescreen viewport: 20⅞"W x 14½"H (511mm W x 368mm H)

21x24 widescreen viewport: 22½"W x 19"H (572mm W x 482mm H)

Surface Mount Arm

Maximum weight for widescreen: 21 lbs.

Maximum dimensions for widescreen: Up to 24" diagonal widescreen

Model Number Structure

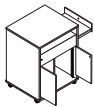

67 - Series
66 - Lectern
67 - Lectern, w/ pull-out shelf

LS - Type
DP - Desktop lectern
LC - Lectern with curved top
LD - Lectern w/ D-top
LP - Lectern with privacy sides
LS - Lectern with squared top

303641 - Size
D x W x H

LM - Modesty Combination for Laminate modesty

LC - Laminate modesty panels & CPU shelf
LD - Laminate modesty panels & CPU compartment with door
LL - Laminate modesty; D-top left
LM - Laminate modesty panels
LR - Laminate modesty; D-top right
LX - Laminate modesty; No CPU shelf

Modesty Combination for perforated metal modesty

MC - Metal modesty panels & CPU shelf
MD - Metal modesty panels & CPU compartment with door
ML - Metal modesty; D-top left
MM - Metal modesty panels
MR - Metal modesty; D-top right
MX - Metal modesty; No CPU shelf

Laminate Mod
67-LS303641LM

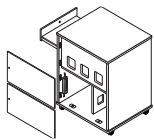

Metal Mod
67-LS303641MM

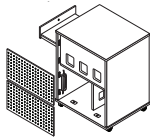

Work Surface Edge Detail & Thickness

Standard
Flat PVC edge 2mm
1" thick



Grommets

Standard grommets are rectangular black plastic.

Door/Drawer Pull Style and Finish



Cup / Black Matt (CB)
Cup / Stainless Steel (CS)
Cup / Chrome Polished (CP)



Steel / Black (SB)
Steel / Chrome Matt (SM)
Steel / Chrome Polished (SP)



Wave / Nickel (WN)
Wave / Black (WB)



Modern / Chrome Matt (MC)
Modern / Black Matt (MB)

To order, specify:

1. Model number.
2. Colors for base and work surface
3. Door/Drawer Pull Style and Finish
4. Optional-Select visual display options

5. Optional - Select essential accessory options

Visual Display Options (Not available on all units, as noted):

- The Trolley™ E / EXL
- Downview - Flat Panel Display
- Surface Mount Arm

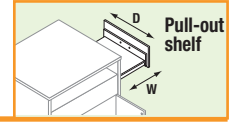

Lecterns with Pull-out Shelf

Locking pull-out shelf for digital presenter on right side. Locking rear access panels. Locking front access panel for digital presenter. Power strip. Casters. Locking doors. Wire access grommets. 30", 36", 42" W lectern have two doors. 48" W lectern has three doors.

Storage Dimensions:

30" W Unit: Rack rails on left side of storage area - 19 1/4" W. Remaining space is 8 5/8" W
 36" W Unit: Left compartment - 14 5/8" W. Right compartment w/ rack rails - 19 1/4" W
 42" W Unit: Left compartment w/ rack rails - 19 1/4" W. Right compartment w/ rack rails - 19 1/4" W
 48" W Unit: Left compartment w/ rack rails - 25 3/4" W. Right compartment w/ rack rails - 19 1/4" W

Suggested Keyboard Width: 30" W Unit: 28" 42" W Unit: 28" 30" D Lecterns: 22-1/4" D x 20-3/8" W x 7-3/4" H
 36" W Unit: 34" 48" W Unit: 28" 36" D Lecterns: 28-1/4" D x 20-3/8" W x 7-3/4" H

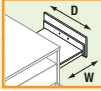

Lectern

Only 48" W lecterns can accommodate Visual Display Options

D x W x H (in.)	ft ³ / lbs	Model	List Price
-----------------	-----------------------	-------	------------

Perforated metal modesty

10 RU rack rails.

30 x 30 x 41	25.5 / 382	67-LS303041MM	\$4,611
30 x 36 x 41	30.3 / 414	67-LS303641MM	\$4,745

36 x 30 x 41	25.5 / 382	67-LS363041MM	\$4,995
36 x 36 x 41	30.3 / 414	67-LS363641MM	\$5,130

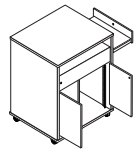

10 RU rack rails

20 RU rack rails (10 RU's on Left; 10 RU's on Right).

30 x 42 x 41	35.1 / 456	67-LS304241MM	\$4,818
30 x 48 x 41	39.9 / 508	67-LS304841MM	\$4,958

36 x 42 x 41	35.1 / 456	67-LS364241MM	\$5,213
36 x 48 x 41	39.9 / 508	67-LS364841MM	\$5,352

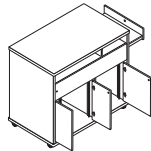

20 RU rack rails
3 drs. avail. on 48" W only

Laminate modesty

10 RU rack rails.

30 x 30 x 41	22.6 / 382	67-LS303041LM	\$3,852
30 x 36 x 41	26.8 / 414	67-LS303641LM	\$3,963

36 x 30 x 41	22.6 / 382	67-LS363041LM	\$4,194
36 x 36 x 41	26.8 / 414	67-LS363641LM	\$4,304

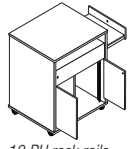

10 RU rack rails

20 RU rack rails (10 RU's on Left; 10 RU's on Right).

30 x 42 x 41	31.0 / 456	67-LS304241LM	\$4,025
30 x 48 x 41	35.2 / 508	67-LS304841LM	\$4,140

36 x 42 x 41	31.0 / 456	67-LS364241LM	\$4,384
36 x 48 x 41	35.2 / 508	67-LS364841LM	\$4,488

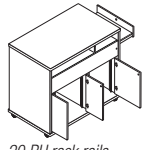

20 RU rack rails
3 drs. avail. on 48" W only

Lectern with Privacy Sides

Only 48" W lecterns can accommodate Visual Display Options

Perforated metal modesty

10 RU rack rails.

30 x 30 x 46 1/2	26.7 / 386	67-LP303047MM	\$4,775
30 x 36 x 46 1/2	31.7 / 418	67-LP303647MM	\$4,911

36 x 30 x 46 1/2	26.7 / 386	67-LP363047MM	\$5,160
36 x 36 x 46 1/2	31.7 / 418	67-LP363647MM	\$5,297

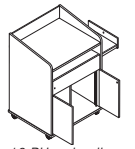

10 RU rack rails

20 RU rack rails (10 RU's on Left; 10 RU's on Right).

30 x 42 x 46 1/2	36.7 / 460	67-LP304247MM	\$4,983
30 x 48 x 46 1/2	41.7 / 512	67-LP304847MM	\$5,123

36 x 42 x 46 1/2	36.7 / 460	67-LP364247MM	\$5,376
36 x 48 x 46 1/2	41.7 / 512	67-LP364847MM	\$5,517

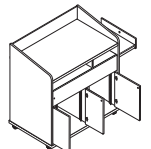

20 RU rack rails
3 drs. avail. on 48" W only

D x W x H (in.)	ft ³ / lbs	Model	List Price
-----------------	-----------------------	-------	------------

Laminate modesty

10 RU rack rails.

30 x 30 x 46 1/2	23.8 / 386	67-LP303047LM	\$3,990
30 x 36 x 46 1/2	28.2 / 418	67-LP303647LM	\$4,101

36 x 30 x 46 1/2	23.8 / 386	67-LP363047LM	\$4,331
36 x 36 x 46 1/2	28.2 / 418	67-LP363647LM	\$4,440

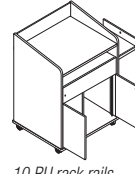

10 RU rack rails

20 RU rack rails (10 RU's on Left; 10 RU's on Right).

30 x 42 x 46 1/2	35 / 460	67-LP304247LM	\$4,164
30 x 48 x 46 1/2	39.2 / 512	67-LP304847LM	\$4,278

36 x 42 x 46 1/2	41.13 / 460	67-LP364247LM	\$4,513
36 x 48 x 46 1/2	47 / 512	67-LP364847LM	\$4,626

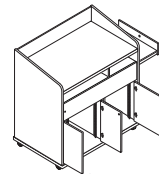

20 RU rack rails
3 drs. avail. on 48" W only

Lectern with Curved Top & Bottom

Only 48" / 54" W lecterns can accommodate Visual Display Options

Perforated metal modesty

10 RU rack rails.

30 x 30/36* x 41	30.3 / 383	67-LC303641MM	\$5,107
30 x 36/42* x 41	35.1 / 415	67-LC304241MM	\$5,242

36 x 30/36* x 41	30.3 / 383	67-LC363641MM	\$5,491
36 x 36/42* x 41	35.1 / 415	67-LC364241MM	\$5,626

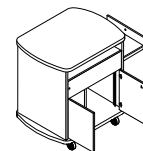

10 RU rack rails

20 RU rack rails (10 RU's on Left; 10 RU's on Right).

30 x 42/48* x 41	39.9 / 456	67-LC304841MM	\$5,314
30 x 48/54* x 41	44.6 / 507	67-LC305441MM	\$5,454

36 x 42/48* x 41	39.9 / 456	67-LC364841MM	\$5,707
36 x 48/54* x 41	44.6 / 507	67-LC365441MM	\$5,849

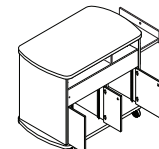

20 RU rack rails
3 drs. avail. on 48" W only

*Chassis width / Top width

Laminate modesty

10 RU rack rails.

30 x 30/36* x 41	26.8 / 383	67-LC303641LM	\$4,266
30 x 36/42* x 41	31.0 / 415	67-LC304241LM	\$4,378

36 x 30/36* x 41	26.8 / 383	67-LC363641LM	\$4,609
36 x 36/42* x 41	31.0 / 415	67-LC364241LM	\$4,719



10 RU rack rails

20 RU rack rails (10 RU's on Left; 10 RU's on Right).

30 x 42/48* x 41	35.2 / 456	67-LC304841LM	\$4,439
30 x 48/54* x 41	39.5 / 507	67-LC305441LM	\$4,555

36 x 42/48* x 41	35.2 / 456	67-LC364841LM	\$4,788
36 x 48/54* x 41	39.5 / 507	67-LC365441LM	\$4,903

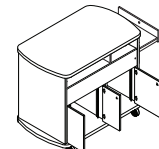

20 RU rack rails
3 drs. avail. on 48" W only

*Chassis width / Top width

Flat PVC edge detail
Thermofused laminate top and base
Laminate or metal modesty panels

Audio/Visual Lecterns

 **ASSEMBLY REQUIRED**

How To Order

1. Select model number

Ex: 67-LS303641LM (Lectern 30x36x41 with pullout shelf and laminate modesty)

2. Select color laminate and work surface (see page 59)

If ordering perforated metal modesty, select metal color

Ex: 129 376 SLL
Base Worksurface Metal

3. Select door/drawer pull style and finish

Ex: CB (Cup pull with Black Matt finish)

OPTIONS

4. Select visual display options (see page 37)

Ex: TE0724NK (The Trolley E with Nova keyboard drawer)

5. Select essential accessory options (see page 54)

Ex: RWG01 (Round wire grommet)

Lecterns

36" W - 48"W available with all Visual Display Options
Trolley EXL not available on 30" W lectern

Locking rear access panels. Power strip. Casters. Locking doors. Wire access grommets.
30", 36", 42" W lectern have two doors. 48" W lectern has three doors.

Storage Dimensions:

30" W Unit: Rack rails on left side of storage area - 19 1/4" W. Remaining space is 8 5/8" W
36" W Unit: Left compartment - 14 5/8" W. Right compartment w/ rack rails - 19 1/4" W
42" W Unit: Left compartment w/ rack rails - 19 1/4" W. Right compartment w/ rack rails - 19 1/4" W
48" W Unit: Left compartment w/ rack rails - 25 3/4" W. Right compartment w/ rack rails - 19 1/4" W

Suggested Keyboard Width:

30" W Unit: 28" / 36" W Unit: 34" / 42" W Unit: 28" / 48" W Unit: 28"

D x W x H (in.)	ft ³ / lbs	Model	List Price
-----------------	-----------------------	-------	------------

Perforated metal modesty 14 RU rack rails.

30 x 30 x 41	25.5 / 372	66-LS303041MM	\$4,059
30 x 36 x 41	30.3 / 404	66-LS303641MM	\$4,194

36 x 30 x 41	25.5 / 372	66-LS363041MM	\$4,445
36 x 36 x 41	30.3 / 404	66-LS363641MM	\$4,580

28 RU rack rails (14 RU's on Left; 14 RU's on Right).

30 x 42 x 41	35.1 / 446	66-LS304241MM	\$4,266
30 x 48 x 41	39.9 / 498	66-LS304841MM	\$4,406

36 x 42 x 41	35.1 / 446	66-LS364241MM	\$4,661
36 x 48 x 41	39.9 / 498	66-LS364841MM	\$4,801

Laminate modesty 14 RU rack rails.

30 x 30 x 41	22.6 / 372	66-LS303041LM	\$3,391
30 x 36 x 41	26.8 / 404	66-LS303641LM	\$3,502

36 x 30 x 41	22.6 / 372	66-LS363041LM	\$3,733
36 x 36 x 41	26.8 / 404	66-LS363641LM	\$3,842

28 RU rack rails (14 RU's on Left; 14 RU's on Right).

30 x 42 x 41	31.0 / 446	66-LS304241LM	\$3,563
30 x 48 x 41	35.2 / 498	66-LS304841LM	\$3,679

36 x 42 x 41	31.0 / 446	66-LS364241LM	\$3,912
36 x 48 x 41	35.2 / 498	66-LS364841LM	\$4,027

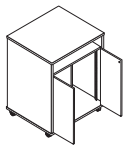

14 RU rack rails

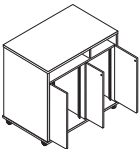

28 RU rack rails
3 drs. avail. on 48" W only

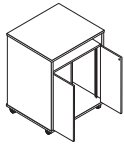

14 RU rack rails

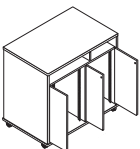

28 RU rack rails
3 drs. avail. on 48" W only

Lecterns with Privacy Sides

36" W - 48"W available with all Visual Display Options
Trolley EXL not available on 30" W lectern

D x W x H (in.)	ft ³ / lbs	Model	List Price
-----------------	-----------------------	-------	------------

Perforated metal modesty

14 RU rack rails.

30 x 30 x 46 1/2	26.7 / 376	66-LP303047MM	\$4,224
30 x 36 x 46 1/2	31.7 / 408	66-LP303647MM	\$4,358

36 x 30 x 46 1/2	26.7 / 376	66-LP363047MM	\$4,609
36 x 36 x 46 1/2	31.7 / 408	66-LP363647MM	\$4,743

28 RU rack rails (14 RU's on Left; 14 RU's on Right).

30 x 42 x 46 1/2	36.7 / 450	66-LP304247MM	\$4,432
30 x 48 x 46 1/2	41.7 / 502	66-LP304847MM	\$4,571

36 x 42 x 46 1/2	36.7 / 450	66-LP364247MM	\$4,825
36 x 48 x 46 1/2	41.7 / 502	66-LP364847MM	\$4,965

Laminate modesty

14 RU rack rails.

30 x 30 x 46 1/2	23.8 / 376	66-LP303047LM	\$3,529
30 x 36 x 46 1/2	28.2 / 408	66-LP303647LM	\$3,640

36 x 30 x 46 1/2	23.8 / 376	66-LP363047LM	\$3,870
36 x 36 x 46 1/2	28.2 / 408	66-LP363647LM	\$3,979

28 RU rack rails (14 RU's on Left; 14 RU's on Right).

30 x 42 x 46 1/2	32.6 / 450	66-LP304247LM	\$3,703
30 x 48 x 46 1/2	37.1 / 502	66-LP304847LM	\$3,817

36 x 42 x 46 1/2	32.6 / 450	66-LP364247LM	\$4,052
36 x 48 x 46 1/2	37.1 / 502	66-LP364847LM	\$4,165

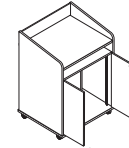

14 RU rack rails

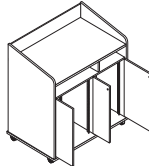

28 RU rack rails
3 drs. avail. on 48" W only

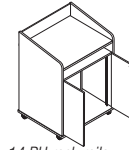

14 RU rack rails

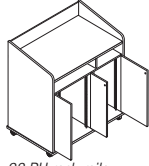

28 RU rack rails
3 drs. avail. on 48" W only

Lectern with Curved Top & Bottom

36" W - 48"W available with all Visual Display Options
Trolley EXL not available on 30" W lectern

Perforated metal modesty

14 RU rack rails.

30 x 30/36* x 41	30.3 / 378	66-LC303641MM	\$4,555
30 x 36/42* x 41	35.1 / 410	66-LC304241MM	\$4,690

36 x 30/36* x 41	30.3 / 378	66-LC363641MM	\$4,941
36 x 36/42* x 41	35.1 / 410	66-LC364241MM	\$5,074

28 RU rack rails (14 RU's on Left; 14 RU's on Right).

30 x 42/48* x 41	39.9 / 452	66-LC304841MM	\$4,762
30 x 48/54* x 41	44.6 / 504	66-LC305441MM	\$4,902

36 x 42/48* x 41	39.9 / 452	66-LC364841MM	\$5,156
36 x 48/54* x 41	44.6 / 504	66-LC365441MM	\$5,295

*Chassis width / Top width

Laminate modesty

14 RU rack rails.

30 x 30/36* x 41	26.8 / 378	66-LC303641LM	\$3,805
30 x 36/42* x 41	31.0 / 410	66-LC304241LM	\$3,917

36 x 30/36* x 41	26.8 / 378	66-LC363641LM	\$4,148
36 x 36/42* x 41	31.0 / 410	66-LC364241LM	\$4,256

28 RU rack rails (14 RU's on Left; 14 RU's on Right).

30 x 42/48* x 41	35.2 / 452	66-LC304841LM	\$3,979
30 x 48/54* x 41	39.5 / 504	66-LC305441LM	\$4,094

36 x 42/48* x 41	35.2 / 452	66-LC364841LM	\$4,211
36 x 48/54* x 41	39.5 / 504	66-LC365441LM	\$4,327

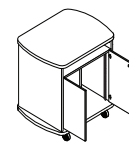

14 RU rack rails

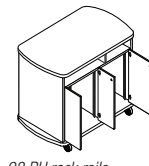

28 RU rack rails
3 drs. avail. on 48" W only

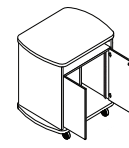

14 RU rack rails

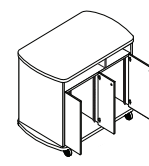

28 RU rack rails
3 drs. avail. on 48" W only

*Chassis width / Top width

To order, specify:

1. Model number.
2. Colors for base and work surface
3. Door/Drawer Pull Style and Finish
4. Optional-Select visual display options

5. Optional - Select essential accessory options

Visual Display Options (Not available on all units, as noted):

- The Trolley™ E / EXL
- Downview - Flat Panel Display
- Surface Mount Arm

Seated Height Lecterns

Available with all Visual Display Options

iMod modesty. Rear access panels. Wire management and power strip. Locking doors. 14 RU rack rails in far right compartment: 19 1/4" W. Suggested keyboard width: 30"

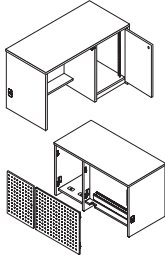

Shown with metal mod

D x W x H (in.)	ft ³ / lbs	Model	List Price
Perforated metal modesty			
26 x 52 1/4 x 30	28.0 / 217	66-LS265230MX	\$1,766
30 x 52 1/4 x 30	32.0 / 229	66-LS305230MX	\$1,862

Laminate modesty			
26 x 52 1/4 x 30	28.0 / 217	66-LS265230LX	\$1,460
30 x 52 1/4 x 30	32.0 / 229	66-LS305230LX	\$1,539

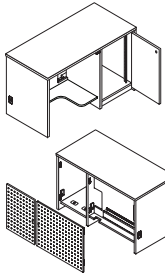

Shown with metal mod

CPU shelf. CPU storage width: 8 1/2"
Not available with Trolley™ EXL.

Perforated metal modesty			
26 x 52 1/4 x 30	28.0 / 236	66-LS265230MC	\$1,851
30 x 52 1/4 x 30	32.0 / 248	66-LS305230MC	\$1,947

Laminate modesty			
26 x 52 1/4 x 30	28.0 / 236	66-LS265230LC	\$1,545
30 x 52 1/4 x 30	32.0 / 248	66-LS305230LC	\$1,625

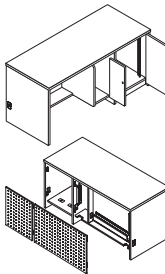

Shown with metal mod

Locking CPU door. CPU storage width: 10" (8" w/ Trolley™ EXL)

Perforated metal modesty			
26 x 60 1/4 x 30	32.2 / 255	66-LS266030MD	\$2,152
30 x 60 1/4 x 30	36.8 / 267	66-LS306030MD	\$2,247

Laminate modesty			
26 x 60 1/4 x 30	32.2 / 255	66-LS266030LD	\$1,809
30 x 60 1/4 x 30	36.8 / 267	66-LS306030LD	\$1,889

Sit-Stand Lecterns

Available with all Visual Display Options

iMod modesty. Rear access panels. Wire management and power strip. Locking doors. 12 RU rack rails in far right compartment: 19 1/4" W. Suggested keyboard width: 30"

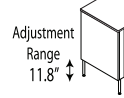

Electrically adjustable unit from 30" base height with 11.8" travel. Rocker switch, internal limit switches and thermal overload protection. ADA compliant. System lift capacity up to 750 lbs.

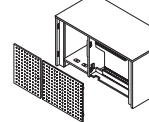
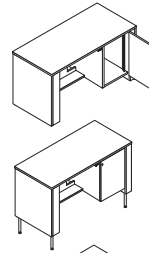

Shown with metal mod

D x W x H (in.)	ft ³ / lbs	Model	List Price
Perforated metal modesty			
30 x 58 1/4 x 30	35.0 / 267	66-SS305730MX	\$4,896

Laminate modesty			
30 x 58 1/4 x 30	35.0 / 267	66-SS305730LX	\$4,574

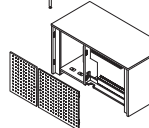
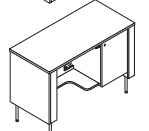
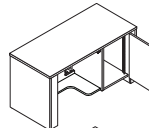

Shown with metal mod

CPU shelf. CPU storage width: 10 1/2"
Not available with Trolley™ EXL

Perforated metal modesty			
30 x 58 1/4 x 30	35.0 / 286	66-SS305730MC	\$4,980

Laminate modesty			
30 x 58 1/4 x 30	35.0 / 286	66-SS305730LC	\$4,659

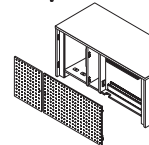
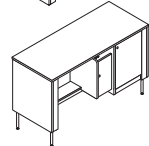
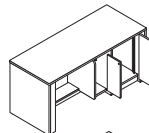

Shown with metal mod

Locking CPU door. CPU storage width: 10" (8" w/ Trolley™ EXL)

Perforated metal modesty			
30 x 66 1/4 x 30	39.8 / 305	66-SS306530MD	\$5,281

Laminate modesty			
30 x 66 1/4 x 30	39.8 / 305	66-SS306530LD	\$4,923

Flat PVC edge detail
Thermofused laminate top and base
Laminate or metal modesty panels

Audio/Visual Lecterns

 **ASSEMBLY REQUIRED**

How To Order

1. Select model number

Ex: 67-LS303641LM (Lectern 30x36x41 with pullout shelf and laminate modesty)

2. Select color laminate and work surface (see page 59)

If ordering perforated metal modesty, select metal color

Ex: 129 376 SLL
Base Worksurface Metal

3. Select door/drawer pull style and finish

Ex: CB (Cup pull with Black Matt finish)

OPTIONS

4. Select visual display options (see page 37)

Ex: TE0724NK (The Trolley E with Nova keyboard drawer)

5. Select essential accessory options (see page 54)

Ex: RWG01 (Round wire grommet)

Lecterns with Optional D-top Workstation

D x W x H (in.)	ft ³ / lbs	Model	List Price
Lectern-Door swing Left			
Power strip. Locking rear access panels. 1 adjustable shelf. 1 fixed shelf. Locking door. 16 RU rack rails. Work surface height: (User side) 41-1/8". Storage Dimensions: 19 1/4" W			
Perforated metal modesty			
21 x 21 x 50	16.6 / —	66-LD212150MR	\$1,387
30 x 30 x 50	32.0 / —	66-LD303050MR	\$2,083
Laminate modesty			
21 x 21 x 50	16.6 / —	66-LD212150LR	\$1,159
30 x 30 x 50	32.0 / —	66-LD303050LR	\$1,855
Optional D-top Workstation on Right			
Perforated metal modesty Attaches to right side of 66-LD212150LMR or 66-LD303050MR. Available with E Trolley, *FPA1621NK and Surface Mount Arm. Suggested keyboard width: 28"			
21 x 39 x 34	— / —	66-DT213934MR	\$1,107
Laminate modesty			
Attaches to right side of 66-LD212150LR or 66-LD303050LR. Available with E Trolley, *FPA1621NK and Surface Mount Arm. Suggested keyboard width: 28"			
21 x 39 x 34	20.8 / —	66-DT213934LR	\$740

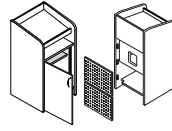

Shown with metal mod

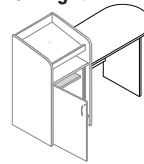

Lectern with Shelves

Available with all Visual Display Options

Locking modesty. Rear access panels. Wire management and power strip. Locking doors.

- Available with heavy duty casters (Specify "C" and add \$366). Height will increase by 2 3/4".
- Available with Flip-up Shelf. For factory prep, must specify "U" for left-handed or "V" for right-handed placement.

Suggested Keyboard Width: 34" **CPU Storage Width:** 36W Unit = 8 7/8" min. 48W Unit = 17" 42W Unit = 11" 60W Unit = 23"

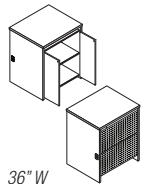

36" W

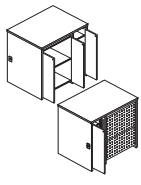

42", 48", 60" W

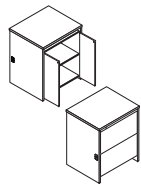

36" W

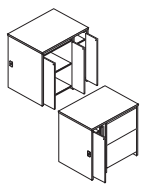

42", 48", 60" W

Perforated metal Total Access modesty

2 fixed shelves.

24 x 36 x 40	24.1 / 194	66-LS243640MD	\$2,513
30 x 36 x 40	29.6 / 196	66-LS303640MD	\$2,577
36 x 36 x 40	35.1 / 231	66-LS363640MD	\$2,854

2 adjustable shelves & 1 fixed shelf. Rear access door. Separate compartment on right with door.

24 x 42 x 40	27.9 / 212	66-LS244240MD	\$2,994
24 x 48 x 40	31.6 / 224	66-LS244840MD	\$3,088
24 x 60 x 40	41.0 / 236	66-LS246040MD	\$3,423

30 x 42 x 40	34.3 / 294	66-LS304240MD	\$3,060
30 x 48 x 40	38.9 / 306	66-LS304840MD	\$3,154
30 x 60 x 40	50.5 / 318	66-LS306040MD	\$3,499

36 x 42 x 40	40.7 / 323	66-LS364240MD	\$3,447
36 x 48 x 40	46.2 / 375	66-LS364840MD	\$3,461

Laminate Total Access modesty

2 fixed shelves.

24 x 36 x 40	24.1 / 194	66-LS243640LD	\$2,222
30 x 36 x 40	29.6 / 196	66-LS303640LD	\$2,288
36 x 36 x 40	35.1 / 231	66-LS363640LD	\$2,564

2 adjustable shelves & 1 fixed shelf. Rear access door. Separate compartment on right with door.

24 x 42 x 40	27.9 / 212	66-LS244240LD	\$2,705
24 x 48 x 40	31.6 / 224	66-LS244840LD	\$2,799
24 x 60 x 40	41.0 / 236	66-LS246040LD	\$3,134

30 x 42 x 40	34.3 / 294	66-LS304240LD	\$2,771
30 x 48 x 40	38.9 / 306	66-LS304840LD	\$2,835
30 x 60 x 40	50.5 / 318	66-LS306040LD	\$3,209

36 x 42 x 40	40.7 / 323	66-LS364240LD	\$3,156
36 x 48 x 40	46.2 / 375	66-LS364840LD	\$3,171

Lectern-Door swing Right

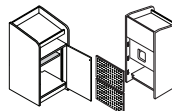

Shown with metal mod

Optional D-top Workstation on Left

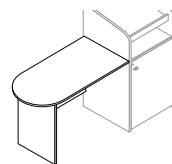

Power strip. Locking rear access panels. 1 adjustable shelf. 1 fixed shelf. Locking door. 16 RU rack rails. Work surface height: (User side) 41-1/8". Storage Dimensions: 19 1/4" W

Perforated metal modesty

21 x 21 x 50	16.6 / —	66-LD212150ML	\$1,387
30 x 30 x 50	32.0 / —	66-LD303050ML	\$2,083

Laminate modesty

21 x 21 x 50	16.6 / —	66-LD212150LL	\$1,159
30 x 30 x 50	32.0 / —	66-LD303050LL	\$1,855

Perforated metal modesty

Attaches to left side of 66-LD212150ML or 66-LD303050ML. Available with E Trolley, *FPA1621NK and Surface Mount Arm. Suggested keyboard width: 28"

21 x 39 x 34	— / —	66-DT213934ML	\$1,107
--------------	-------	---------------	---------

Laminate modesty

Attaches to left side of 66-LD212150LL or 66-LD303050LL. Available with E Trolley, *FPA1621NK and Surface Mount Arm. Suggested keyboard width: 28"

21 x 39 x 34	20.8 / —	66-DT213934LL	\$740
--------------	----------	---------------	-------

*FPA1621NK Flat Panel Arm will be mounted to modesty panel.

To order, specify:

1. Model number.
2. Colors for base and work surface
3. Door/Drawer Pull Style and Finish
4. Optional-Select visual display options

5. Optional - Select essential accessory options

Visual Display Options (Not available on all units, as noted):

- The Trolley™ E / EXL
- Downview - Flat Panel Display
- Surface Mount Arm

Miscellaneous

D x W x H (in.)	ft ³ / lbs	Model	List Price
-----------------	-----------------------	-------	------------

Lectern with angled top

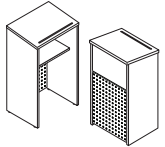

Shown with metal mod

1 fixed shelf. Pencil lip - standard is black.

Perforated metal modesty

18 x 18 x 44	10.7 / 86	66-LS181844MM	\$936
21 x 24 x 44	16.0 / 86	66-LS212444MM	\$1,325

Laminate modesty

18 x 18 x 44	10.7 / 86	66-LS181844LM	\$667
21 x 24 x 44	16.0 / 86	66-LS212444LM	\$1,009

NOT AVAILABLE WITH VISUAL DISPLAY OPTIONS

Lectern with angled top and privacy sides

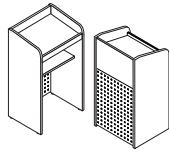

Shown with metal mod

1 fixed shelf.

Perforated metal modesty

18 x 18 x 44	10.7 / 86	66-LP181844MM	\$936
21 x 24 x 44	16.0 / 86	66-LP212444MM	\$1,325

Laminate modesty

18 x 18 x 44	10.7 / 86	66-LP181844LM	\$657
21 x 24 x 44	16.0 / 86	66-LP212444LM	\$1,009

NOT AVAILABLE WITH VISUAL DISPLAY OPTIONS

Mobile cart

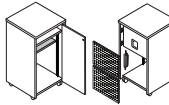

Shown with metal mod

1 adjustable interior shelf. 1 fixed shelf. 2 casters. Power strip. Locking door. 16 RU rack rails. Storage dimensions: 19 3/4" W

Perforated metal modesty

24 x 21 x 36	13.2 / 86	66-LC242136MM	\$1,586
--------------	-----------	---------------	---------

Laminate modesty

24 x 21 x 36	13.2 / 86	66-LC242136LM	\$1,322
--------------	-----------	---------------	---------

NOT AVAILABLE WITH VISUAL DISPLAY OPTIONS

Mobile cart with raised sides

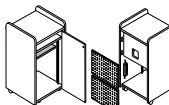

Shown with metal mod

1 adjustable interior shelf. 1 fixed shelf. 2 casters. Power strip. Locking door. 16 RU rack rails. Storage dimensions: 19 3/4" W

Perforated metal modesty

24 x 21 x 38	13.9 / 86	66-LC242138MM	\$1,658
--------------	-----------	---------------	---------

Laminate modesty

24 x 21 x 38	13.9 / 86	66-LC242138LM	\$1,381
--------------	-----------	---------------	---------

NOT AVAILABLE WITH VISUAL DISPLAY OPTIONS

Desktop lectern



Freestanding. Available in base color only.

17 x 24 x 17	5.5 / 37	66-DP172417	\$317
--------------	----------	-------------	-------

NOT AVAILABLE WITH VISUAL DISPLAY OPTIONS

Options for Audio/Visual Lecterns with Laminate and Perforated Metal Modestys

Flip-up shelf

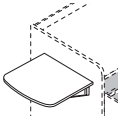

Shipped Separately. Color matches work surface of lectern ordered. Located 3" down from work surface. For factory prep, must specify "U" on lectern model number for left-handed, or "V" on lectern model number for right-handed placement.

For 21" D Lectern:

Attaches to the LEFT side panel of Lectern.

20 x 20 x 01	0.9 / 24	66-SH202001L	\$511
--------------	----------	--------------	-------

Attaches to the RIGHT side panel of Lectern.

20 x 20 x 01	0.9 / 24	66-SH202001R	\$511
--------------	----------	--------------	-------

For 30" D or 36" D Lectern:

Attaches to the LEFT side panel of Lecterns.

22 x 20 x 01	1.0 / 24	66-SH222001L	\$511
--------------	----------	--------------	-------

Attaches to the RIGHT side panel of Lecterns.

22 x 20 x 01	1.0 / 24	66-SH222001R	\$511
--------------	----------	--------------	-------

2 space rack drawer

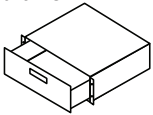

Attaches to rack rails. Takes up 2RU space. 50 lb. weight capacity.

20 x 15 x 3½	10.4 / 20	66-2DRAWER	\$560
--------------	-----------	------------	-------

Sliding shelf

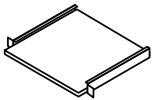

Attaches to rack rails. 35 lb. weight capacity.

20 x 15 x 01	10.4 / 15	66-SSHELF	\$369
--------------	-----------	-----------	-------

2 space rack shelf

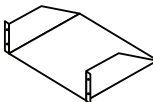

Attaches to rack rails. Takes up 2RU space. 50 lb. weight capacity.

20 x 15 x 3½	10.4 / 15	66-2SHELF	\$216
--------------	-----------	-----------	-------

Removable console

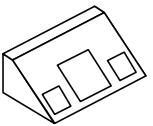

04 x 28 x 01	2.0 / 20	66-CONSOLE01	\$644
--------------	----------	--------------	-------

Ventilation fan



Specify cutout location on lectern. 115V fan rated at 57 CFM. 30 dBA.

01 x 06 x 06	2.0 / 3	66-FAN	\$226
--------------	---------	--------	-------

Factory Installed Keyboard Options (Only ordered when NO Visual Display Options ordered)

Factory Installed Nova Keyboard

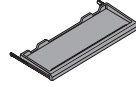

Keyboard length to fit lectern ordered

22" - 34" wide	13	NK	\$123
----------------	----	----	-------

Factory Installed Center Mount Articulating Keyboard Mechanism & Tray

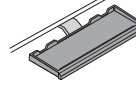

Keyboard length to fit lectern ordered

28", 30", 34" wide	15	CK	\$256
--------------------	----	----	-------

Visual Display Options

* Adding a Flat Panel Arm or Trolley visual display option may affect CPU storage widths.

For Audio/Visual Lecterns

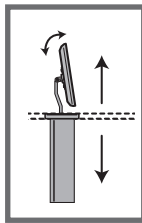

The Trolley™

Trolley does not come installed in any unit.

Maximum distance from center of wall mount VESA plate to bottom of monitor is 6 3/4" (171mm)

The Trolley™ EXL

Maximum Dimensions for Widescreen:

2 1/2" D x 22 7/8" W x 14 1/2" H
up to 24" diagonal widescreen
36" min. worksurface width

The Trolley™ E

Maximum Dimensions for Widescreen:

2 1/2" D x 18 7/8" W x 14 1/2" H
up to 21" (diagonal) or
20" (widescreen)

- Low voltage motor to lift & lower monitor
- Provides vertical tilt adjustment in "up" position
- Durable metal enclosure under desktop
- Wire management system and power strip included

Model	Wt.	List Price
-------	-----	------------

With Nova Keyboard Drawer

Nova Keyboard Drawer installed in assembled units only.

TE0728NK	48	The Trolley EXL with Nova Keyboard drawer	\$1,775 ea
36" min. worksurface width required			

TE0724NK	48	The Trolley E with Nova Keyboard drawer	\$1,339 ea.
----------	----	---	-------------

International Customers: Trolleys include Universal Power Control Units, compatible with all power requirements inside and outside the U.S.

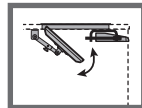

Downview™

18"D x 18"W viewport

Maximum Dimensions for Widescreen: 17"W x 14 1/2"H
up to 19" diagonal
26" min. work surface depth

16"D x 21"W viewport (Widescreen)

Maximum Dimensions for Widescreen: 19 1/2"W x 12 1/2" H
up to 21" widescreen
24" min. work surface depth

21"D x 21"W viewport

Maximum Dimensions for Widescreen: 20 1/8"W x 19"H
up to 21" diagonal
30" min. work surface depth

18"D x 21"W viewport (Widescreen)

Maximum Dimensions for Widescreen: 20 1/8"W x 14 1/2"H
up to 21" widescreen
26" min. work surface depth

- Tinted, tempered glass viewport
- Keeps monitor under glass below work surface
- Wire management system and power strip included

21"D x 24"W viewport (Widescreen)

Maximum Dimensions for Widescreen: 22 1/2"W x 19"H
up to 23" widescreen
30" min. work surface depth
36" min. work surface width

Model	Wt.	List Price
-------	-----	------------

With Nova Keyboard Drawer

Downview & Nova Keyboard Drawer installed in assembled units only.

FPA1621NK	35	Includes 16"D x 21"W viewport, adjustable arm, and visor.	\$413 ea.
FPA1818NK	35	Includes 18"D x 18"W viewport, adjustable arm, and visor.	\$438 ea.
FPA1821NK	35	Includes 18"D x 21"W viewport, adjustable arm, and visor.	\$438 ea.
FPA2121NK	37	Includes 21"D x 21"W viewport, adjustable arm, and visor.	\$511 ea.
FPA2124NK	39	Includes 21"D x 24"W viewport, adjustable arm, and visor.	\$558 ea.

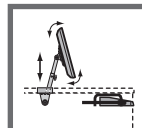

Surface Mount Arm

Surface Mount Arm does not come installed in any unit

Maximum Weight / Dimensions for Widescreen:

21 lbs. / Up to 24" diagonal widescreen

- Wire management system and power strip included

Model	Wt.	List Price
-------	-----	------------

With Nova Keyboard Drawer

Nova Keyboard Drawer installed in assembled units only.

SMA0203NK	13		\$317 ea.
-----------	----	--	-----------

With Center Mount Articulating Keyboard Mechanism and Tray

Center Mount Keyboard Tray installed in assembled units only.

SMA0203CK	15		\$523 ea.
-----------	----	--	-----------

- For details and installation specifications, refer to pages 47-51.
- For CRT applications, please contact Customer Support: 1-800-730-6682

Collaboration





Collaboration

Facilitate the benefits of technology enhanced group learning in the following environments..

- Corporate Training Rooms
- College & University Classrooms
- Government Training Facilities
- Distance Learning Environments
- Testing Centers
- K-12 Classrooms
- Conference Rooms
- Government & Private Security Centers
- Libraries
- Computer Labs
- Common Areas & Lobbies
- Healthcare Facilities
- Correctional Institutions

Take peer interaction to the next level.

Flat PVC edge banding
Thermofused laminate top

Collaboration Tables

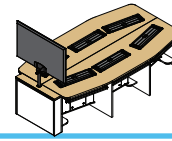

ASSEMBLY REQUIRED

How To Order

- Select model number**
Ex: 46-CR919630CS (*Collaboration Table, Round, 6-Seats*)
- Select laminate base and work surface color (see page 59)**
Ex: 227 044
Base Worksurface

OPTIONS

- Select visual display options (see page 24)**
Ex: TE0724NK (The Trolley E with Nova keyboard drawer)
- Select essential options (see page 54)**
Ex: RWG01 (Round wire grommet)

Wire management system and power strip included.
Monitor and mounting pole NOT included.

Trolley VDO shown for illustration ONLY. Not included in pricing. Pricing shown is without Visual Display Options or Accessories.

Model Number Structure

	46 Series	-	CR Type	919630 Size	CS Options
46-CR919630CS			CR-Round Shape Table CT-Tree Shape Table CD-Diamond Shape Table	D x W x H	CS-Starter AD-with ADA Lift CX-No CPU AX-ADA Lift, No CPU

Work Surface Edge Detail

Standard
Flat PVC edge 2mm
1" thick



NOVALinked™ is a networking system that provides complete control of NOVA's Trolley E monitor lifts in a classroom or training room setting. To order, see page 26.

Collaboration Tables

Available Visual Display Options — Trolley E or EXL with Nova Keyboard, Downview (FPA1621NK only), Surface Mount Arm (SMA0203NK only).

Two-piece, 6 person table. Center laminate base.

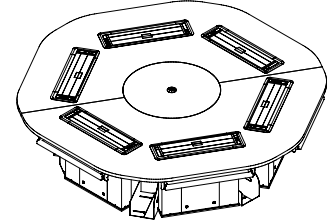
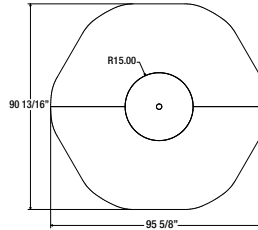

D x W x H (in.)	Seats	Model	List Price
90-13/16 x 95-5/8 x 30	6	46-CR919630CS	\$10,857

With ADA electric hydraulic lift option. Available for 1-user. Electrically adjustable base height from 30" with 2 1/2" travel.

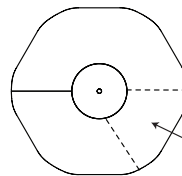

90-13/16 x 95-5/8 x 30		46-CR919630AD	\$14,217
------------------------	--	----------------------	-----------------

ADA Electric Hydraulic Lift
Raises one section of the work surface.

Available Visual Display Options — Trolley E or EXL with Nova Keyboard, Downview (FPA1621NK), Surface Mount Arm (SMA0203NK only).

Two-piece, 5 person table. Center laminate base.

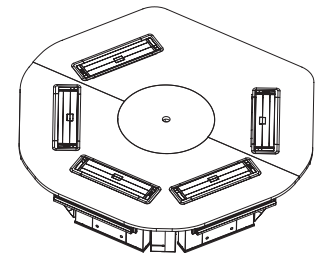
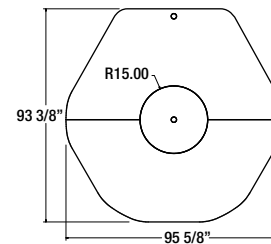

D x W x H (in.)	Seats	Model	List Price
93-3/8 x 95-5/8 x 30	5	46-CR949630CS	\$13,248

With ADA electric hydraulic lift option. Available for 1-user. Electrically adjustable base height from 30" with 2 1/2" travel.

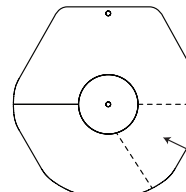

93-3/8 x 95-5/8 x 30		46-CR949630AD	\$16,608
----------------------	--	----------------------	-----------------

ADA Electric Hydraulic Lift
Raises one section of the work surface.

Factory Installed Keyboard Options

(Only ordered when NO Visual Display Options ordered)

Factory Installed Nova Keyboard	Keyboard length to fit casegoods ordered			
	22" - 34" wide	13	NK	\$123

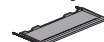

Collaboration Tables

Available Visual Display Options — Trolley E or EXL with Nova Keyboard, Downview (FPA1621NK only), Surface Mount Arm (SMA0203NK only).

CPU shelf width is 7".

	D x W x H (in.)	Seats	Model	List Price
Five Person 6" D x 38" W Compartment on end for cables	60 x 100-5/16 x 30	5	46-CD6010230CS	\$7,652
	With ADA electric hydraulic lift option. Available for user on end. 60 x 100-5/16 x 30 46-CD6010230AD \$11,012			

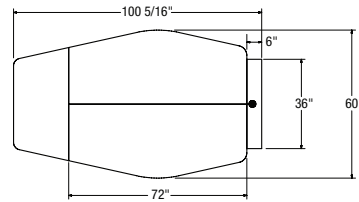
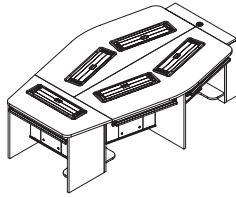

Six Person	60 x 116-5/8 x 30	6	46-CD6012330CS	\$8,629
	With ADA electric hydraulic lift option. Available for user on end. 60 x 116-5/8 x 30 46-CD6012330AD \$11,988			

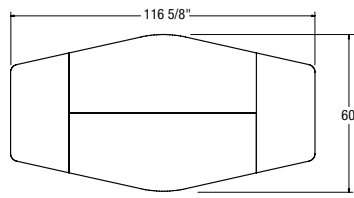
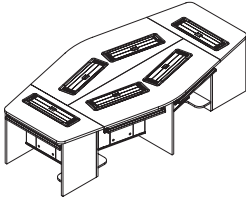

Eight Person	60 x 151-1/2 x 30	8	46-CD6015230CS	\$10,714
	With ADA electric hydraulic lift option. Available for user on end. 60 x 151-1/2 x 30 46-CD6015230AD \$14,074			

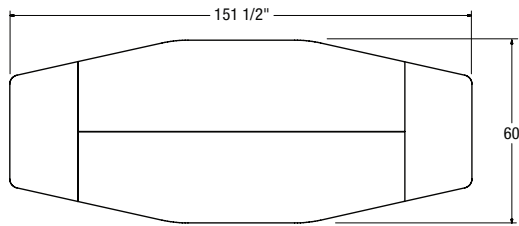
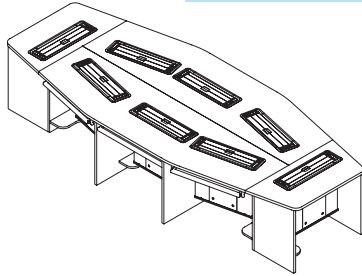

Ten Person	60 x 186-5/16 x 30	10	46-CD6018630CS	\$13,775
	With ADA electric hydraulic lift option. Available for user on end. 60 x 186-5/16 x 30 46-CD6018630AD \$17,135			

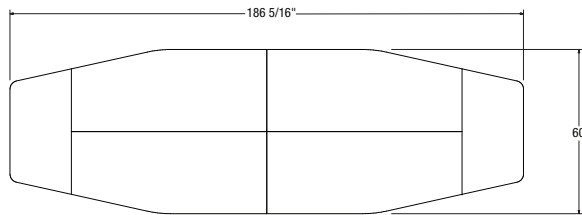
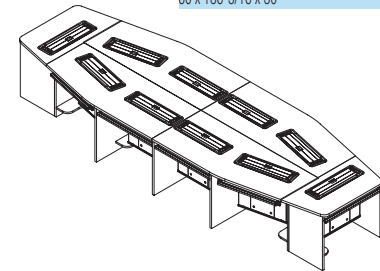

Collaboration Tables

Trolley VDO shown for illustration ONLY. Not included in pricing. Pricing shown is without Visual Display Options or Accessories.

	D x W x H (in.)	Model	List Price	
Six Person 6" D x 38" W Compartment on end for cables	60 x 115-3/16 x 30	6	46-CD6011330CS	\$9,179

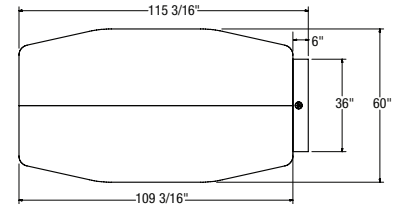
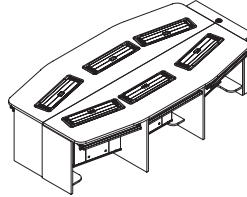

Seven Person 6" D x 38" W Compartment on end for cables	60 x 138-1/16 x 30	7	46-CD6013630CS	\$10,714
	With ADA electric hydraulic lift option. Available for user on end. 60 x 138-1/16 x 30 46-CD6013630AD \$14,074			

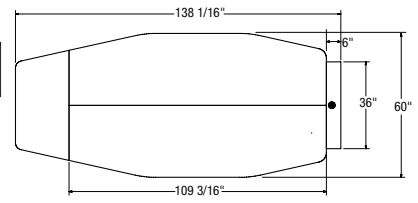
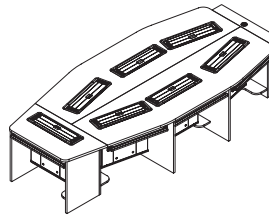

Collaboration Tables

How To Order

1. Select model number

Ex: 46-CR919630CS (Collaboration Table, Round, 6-Seats)

2. Select laminate base and work surface color (see page 59)

Ex: 227 044
Base Worksurface

OPTIONS

4. Select visual display options (see page 24)

Ex: TE0724NK (The Trolley E with Nova keyboard drawer)

5. Select essential options (see page 54)

Ex: RWG01 (Round wire grommet)

Wire management system and power strip included.
Monitor and mounting pole NOT included.

Trolley VDO shown for illustration ONLY. Not included in pricing. Pricing shown is without Visual Display Options or Accessories.



Collaboration Tables

D x W x H (in.) Model List Price

Six Person
6" D x 38" W Compartment
on end for cables

60 x 117-7/16 x 30	6	46-CT6011830CS	\$9,645
--------------------	---	----------------	---------

Seven Person
6" D x 38" W Compartment
on end for cables

60 x 137-3/8 x 30	7	46-CT6014230CS	\$11,175
-------------------	---	----------------	----------

With ADA electric hydraulic lift option. Available for user on end.

60 x 137-3/8 x 30	7	46-CT6014230AD	\$14,294
-------------------	---	----------------	----------

Eight Person
6" D x 38" W Compartment
on end for cables

60 x 154 x 30	8	46-CT6015630CS	\$13,630
---------------	---	----------------	----------



Collaboration Tables

Available Visual Display Options — Trolley E or EXL with Nova Keyboard, Downview (FPA1621NK only), Surface Mount Arm (SMA0203NK only).

CPU shelf width is 7". D x W x H (in.) Seats Model List Price

Four Person
6" D x 38" W Compartment
on end for cables

60 x 82 x 30	4	46-CT608230CS	\$6,584
--------------	---	---------------	---------

Five Person
6" D x 38" W Compartment
on end for cables

60 x 101-5/16 x 30	5	46-CT6010230CS	\$8,115
--------------------	---	----------------	---------

With ADA electric hydraulic lift option. Available for user on end.

60 x 101-5/16 x 30	5	46-CT6010230AD	\$11,234
--------------------	---	----------------	----------

Ten Person
6" D x 38" W Compartment
on end for cables

60 x 191-1/16 x 30	10	46-CT6019230CS	\$15,766
--------------------	----	----------------	----------

How To Order

1. Select model number for table top and base

Ex: 35-BT489601 (boat-shaped top, 48 x 96 x 1)

35-BB244829P (Panel base for 96" top)

2. Select work surface color (see page 59)

Ex: $\frac{604}{\text{base}}$ $\frac{604}{\text{work surface}}$

OPTIONS

4. Select visual display options (see page 24)

Ex: TE0724NK (The Trolley E with Nova keyboard drawer)

5. Select essential accessory options (see page 54)

Ex: RWG01 (Round wire grommet)

Tables

Other base shapes are available: 
For more designs or a quote, contact Customer Support.

	D x W x H (in.)	ft ³ / lbs	Model	List Price
Circular tops 	For table. Order base separately.			
	36 x 36 x 1	2.5 / 80	35-CT363601	\$474
	42 x 42 x 1	3.3 / 90	35-CT424201	\$624
	48 x 48 x 1	4.3 / 100	35-CT484801	\$708

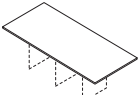
Rectangular tops 	For conference tables.			
	36 x 72 x 1	4.8 / 220	35-RT367201	\$700
	48 x 96 x 1	8.5 / 270	35-RT489601	\$995

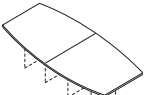
Boat-shaped tops 	For conference tables. 120" and 144" tops are in two pieces.			
	48 x 96 x 1	8.5 / 270	35-BT489601	\$1,095
	48 x 120 x 1	7.1 / 320	35-BT481200	\$1,345
	48 x 144 x 1	8.5 / 370	35-BT481440	\$1,515

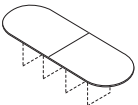
Racetrack tops 	For conference tables. 120" and 144" tops are in two pieces.			
	36 x 72 x 1	4.8 / 210	35-RC367201	\$767
	48 x 96 x 1	8.5 / 260	35-RC489601	\$1,112
	48 x 120 x 1	7.1 / 310	35-RC481200	\$1,407
	48 x 144 x 1	8.5 / 360	35-RC481440	\$1,557

Cross bases



D x W x H (in.)	ft ³ / lbs	Model	List Price
For 35-CT363601 top.			
20 x 20 x 29	1.1 / 40	35-BB202029CB	\$474
For 35-CT424201 top.			
27 x 27 x 29	1.5 / 52	35-BB272729CB	\$542
For 35-CT484801 top.			
33 x 33 x 29	1.8 / 66	35-BB333329CB	\$700

V-base

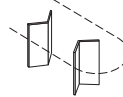

Priced per pair. Tables 72" & 96" require 1 pair. Tables 120" & 144" require 2 pair.			
16 x 16 x 29	1.0 / 36	35-BB161629V	\$708

Panel base

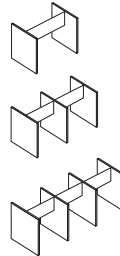

For 72" tables. (Order one per table)			
24 x 36 x 29	1.8 / 60	35-BB243629P	\$615

For 96" tables. (Order one per table)			
24 x 48 x 29	2.3 / 80	35-BB244829P	\$707

For 120" tables. (Order one per table)			
24 x 84 x 29	2.7 / 130	35-BB248429P	\$928

For 144" tables. (Order one per table)			
24 x 108 x 29	2.7 / 160	35-BB2410829P	\$1,052

Cross base

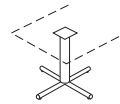

Specify metal color for steel leg.			
33 x 33 x 29	21.9 / 26	35-BB333329CL	\$667

T-base

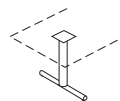

Specify metal color for steel leg.			
02 x 30 x 29	2.2 / 18	35-BB023029T	\$500

Leg base

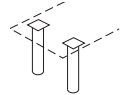

Specify metal color for steel leg. Priced per leg.			
04 x 04 x 29	2.2 / 11	35-BB040429L	\$374

Retrofit

Technology Support Systems

The Trolley™

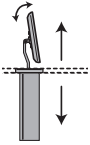

Downview™

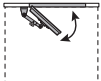

Surface Mount Arm

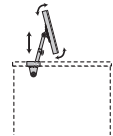

How To Order

1. Select model number

Ex: FPA-0-1818-NK-30 (Flat Panel Arm Kit with 18"x18" viewport and Nova keyboard drawer, 30" wide.)

Model Number Structure

TE - **0** - **0724** - **NK** - **30**
 Technology Type 0724 - Trolley E Keyboard Type Keyboard Size (Width)
 TE - Trolley 0728 - Trolley EXL NK-Nova keyboard CK-Center mount keyboard XK-No keyboard

FPA - **0** - **1818** - **NK** - **30**
 Technology Type Monitor Location Viewport Size (D x W) Keyboard Type Keyboard Size (Width)
 FPA-Flat Panel Arm 0-Fully-Recessed NK-Nova keyboard XK-No keyboard

Technology Description

The Trolley™ Personal Monitor Arm System

Maximum dimensions for widescreen:

EXL: 2½" D x 22 7/8" W x 14½" H

E: 2½" D x 18 7/8" W x 14 1/2" H

NOTE: Maximum distance from center of wall mount VESA plate to bottom of monitor is 6 ¾" (171mm)

- Provides flexible, mainstream flat screen location when raised
- Low voltage motor to lift and lower monitor
- Intelligent Motion Technology™ provides operational intuition
- Clears line-of-sight when submerged
- Allows for multi-use workstations and classrooms
- Hides confidential information when necessary
- Reduces the risk of damage to flat panels displays
- Creates a clean, uncluttered look in the classroom or office
- Reduces the risk of damage to computer equipment
- Provides clean, ergonomical solutions
- Manage technology in your workspace environment

Downview™

Maximum dimensions for widescreen —

18x18 viewport: 17"W x 18"H (432mm x 457.2mm)

21x21 viewport: 20-1/8" W x 19" H (511mm x 482mm)

16x21 widescreen viewport: 19½" W x 12½"H (495mm x 318mm)

18x21 widescreen viewport: 20-1/8" W x 14½"H (511 mm x 368 mm)

21x24 widescreen viewport: 22-1/2" W x 19"H (572 mm x 482 mm)

- Keeps monitor under glass below work surface
- Allows for multi-use working and learning environments
- Proven to be ergonomically beneficial, increase productivity
- Saves premium classroom and desktop space
- Hides confidential information
- Creates a clean, uncluttered look in the classroom
- Reduces the risk of damage to computer equipment

Surface Mount Arm

Maximum weight for widescreen: 21 lbs.

Maximum dimensions for widescreen: Up to 24" diagonal widescreen

- Allows for multi-use working and learning environments
- Proven to be ergonomically beneficial, increase productivity
- Saves premium classroom and desktop space
- Creates a clean, uncluttered look in the classroom or office
- Reduces the risk of damage to computer equipment
- Height and tilt adjustable

RETROFIT KIT PRICING DOES NOT INCLUDE INSTALLATION.

To order, specify:
1. Model number

The Trolley™ E for Widescreens up to 20" widescreen format

For Widescreens that have a VESA standard attachment method on the back.
NOTE: Maximum distance from center of wall mount VESA plate to bottom of monitor is 6¾" (171mm).

- Maximum dimensions for widescreen: 2½" D x 18 7/8" W x 14 1/2" H
- Minimum 28" work surface height required.
- Minimum 24" depth of clearance underneath work surface.
- Weight of widescreen cannot exceed 21 lbs.
- Fits most displays up to 21" diagonal or 20" widescreen

The Trolley E

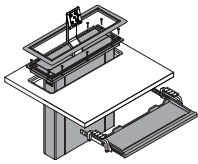

Min. Clearance (Width)	Ft3 / Wt.	Model	List Price
With Nova keyboard drawer.			
22" wide	4.7 / 43	TE-0-0724-NK-22	\$1,490
25-7/8" wide	4.8 / 44	TE-0-0724-NK-24	\$1,490
28-5/8" wide	4.9 / 45	TE-0-0724-NK-27	\$1,490
29-1/2" wide	4.9 / 45	TE-0-0724-NK-28	\$1,490
31-5/8" wide	5.0 / 46	TE-0-0724-NK-30	\$1,490
35-1/2" wide	5.2 / 48	TE-0-0724-NK-34	\$1,490

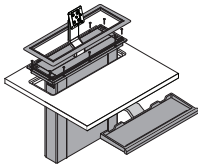

With Center Mount Articulating keyboard drawer.			
28"	5.3 / 47	TE-0-0724-CK-28	\$1,685
30"	5.4 / 47	TE-0-0724-CK-30	\$1,685
34"	5.7 / 47	TE-0-0724-CK-34	\$1,685

Without keyboard drawer			
21"	3.7 / 32	TE-0-0724-XK	\$1,403

Box size: 11"D x 26" W x 26"H

International Customers: E units include Universal Power Control Units, compatible with all power requirements inside and outside the U.S.

The Trolley™ EXL for Widescreens up to 24" widescreen format

- Maximum dimensions for widescreen: 2½" D x 22 7/8" W x 14 1/2" H
- Minimum 28" work surface height required.
- Minimum 24" depth of clearance underneath work surface
- Minimum 27" kneespace width
- Weight of widescreen cannot exceed 21 lbs.
- Fits most displays up to 24" diagonal widescreen

The Trolley EXL

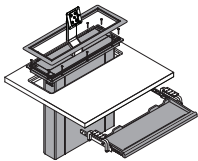

Min. Clearance (Width)	Ft3 / Wt.	Model	List Price
With Nova keyboard drawer.			
28-5/8" wide	4.9 / 45	TE-0-0728-NK-27	\$1,971
29-1/2" wide	4.9 / 45	TE-0-0728-NK-28	\$1,971
31-5/8" wide	5.0 / 46	TE-0-0728-NK-30	\$1,971
35-1/2" wide	5.2 / 48	TE-0-0728-NK-34	\$1,971

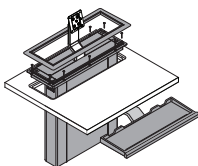

With Center Mount Articulating keyboard drawer.			
28"	5.3 / 47	TE-0-0728-CK-28	\$2,168
30"	5.4 / 47	TE-0-0728-CK-30	\$2,168
34"	5.7 / 47	TE-0-0728-CK-34	\$2,168

Without keyboard drawer			
25"	3.7 / 32	TE-0-0728-XK	\$1,886

Box size: 11"D x 30" W x 26"H

Downview

For Widescreens that have a VESA standard attachment method on the back.

Kit includes: glass, visor, trim ring, Nova keyboard drawer with hangers, and adjustable arm.

- Weight of widescreen cannot exceed 21 lbs.
- Minimum 28" work surface height required.

16"D x 21"W Widescreen Viewport

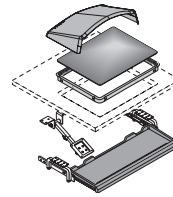

Min. Clearance (Width)	Ft3 / Wt.	Model	List Price
With Nova keyboard drawer			
25-7/8" wide	3.4 / 27	FPA-0-1621-NK-24	\$572
28-5/8" wide	3.4 / 27	FPA-0-1621-NK-27	\$572
29-1/2" wide	3.4 / 27	FPA-0-1621-NK-28	\$572
31-5/8" wide	4.7 / 34	FPA-0-1621-NK-30	\$572
35-1/2" wide	4.9 / 35	FPA-0-1621-NK-34	\$572

Without keyboard drawer			
22"	3.4 / 18	FPA-0-1621-XK	\$481

18"D x 18"W Viewport

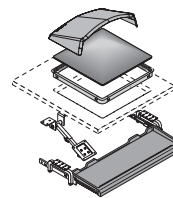

With Nova keyboard drawer			
22" wide	3.4 / 26	FPA-0-1818-NK-22	\$597
25-7/8" wide	3.4 / 27	FPA-0-1818-NK-24	\$597
28-5/8" wide	3.4 / 27	FPA-0-1818-NK-27	\$597
29-1/2" wide	3.4 / 27	FPA-0-1818-NK-28	\$597
31-5/8" wide	4.7 / 34	FPA-0-1818-NK-30	\$597
35-1/2" wide	4.9 / 35	FPA-0-1818-NK-34	\$597

Without keyboard drawer			
19"	3.4 / 18	FPA-0-1818-XK	\$505

18"D x 21"W Widescreen Viewport

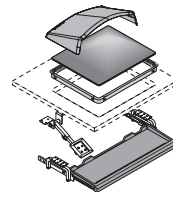

With Nova keyboard drawer			
25-7/8" wide	3.4 / 27	FPA-0-1821-NK-24	\$597
28-5/8" wide	3.4 / 27	FPA-0-1821-NK-27	\$597
29-1/2" wide	3.4 / 27	FPA-0-1821-NK-28	\$597
31-5/8" wide	4.7 / 34	FPA-0-1821-NK-30	\$597
35-1/2" wide	4.9 / 35	FPA-0-1821-NK-34	\$597

Without keyboard drawer			
22"	3.4 / 18	FPA-0-1821-XK	\$505

Retrofit

How To Order

1. Select model number

Ex: FPA-0-1818-NK-30 (Retro, Flat Panel Arm, 18" x 18", Nova Kybd, 30" W)

Downview

For Widescreens that have a VESA standard attachment method on the back. Kit includes: glass, visor, trim ring, Nova keyboard drawer with hangers, and adjustable arm.

- Weight of widescreen cannot exceed 21 lbs.
- Minimum 28" work surface height required.

21"D x 21"W Viewport

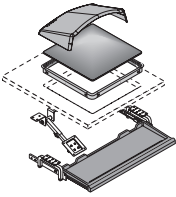

Min. Clearance (Width)	Ft3 / Wt.	Model	List Price
------------------------	-----------	-------	------------

- Maximum dimensions for widescreen: 20-1/8" W x 19" H (511mm x 482mm) *Dimensions do not include display base
- Minimum 27-1/4" depth of clearance underneath work surface.

With Nova keyboard drawer

25-7/8" wide	3.4 / 28	FPA-0-2121-NK-24	\$669
28-5/8" wide	3.4 / 29	FPA-0-2121-NK-27	\$669
29-1/2" wide	3.4 / 29	FPA-0-2121-NK-28	\$669
31-5/8" wide	4.8 / 32	FPA-0-2121-NK-30	\$669
35-1/2" wide	4.9 / 33	FPA-0-2121-NK-34	\$669

Without keyboard drawer

22"	3.4 / 20	FPA-0-2121-XK	\$578
-----	----------	---------------	-------

21"D x 24"W Widescreen Viewport

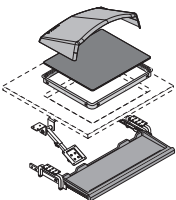

- Maximum dimensions for widescreen: 22-1/2" W x 19" H (572mm x 482mm) *Dimensions do not include display base
- Minimum 27-1/4" depth of clearance underneath work surface.

With Nova keyboard drawer

28-5/8" wide	3.4 / 29	FPA-0-2124-NK-27	\$740
29-1/2" wide	3.4 / 29	FPA-0-2124-NK-28	\$740
31-5/8" wide	4.8 / 32	FPA-0-2124-NK-30	\$740
35-1/2" wide	4.9 / 33	FPA-0-2124-NK-34	\$740

Without keyboard drawer

25"	3.4 / 20	FPA-0-2124-XK	\$651
-----	----------	---------------	-------

Surface Mount Arm

Up to 24" diagonal widescreen

For Widescreens that have a VESA standard attachment method on the back. Kit includes: Surface mount arm and keyboard drawer. Arm mounts under work surface through grommet cutout.

- Weight of widescreen cannot exceed 21 lbs.
- Maximum dimensions for widescreen: Up to 24" diagonal widescreen
- Minimum 18" depth of clearance underneath work surface.

D x W x H	Ft3 / Wt.	Model	List Price
-----------	-----------	-------	------------

Surface Mount Arm With Nova keyboard drawer

22" wide	2.4 / 12	SMA-1-0203-NK-22	\$390
25-7/8" wide	2.5 / 12	SMA-1-0203-NK-24	\$390
28-5/8" wide	2.6 / 12	SMA-1-0203-NK-27	\$390
29-1/2" wide	2.7 / 12	SMA-1-0203-NK-28	\$390
31-5/8" wide	2.8 / 13	SMA-1-0203-NK-30	\$390
35-1/2" wide	2.9 / 13	SMA-1-0203-NK-34	\$390

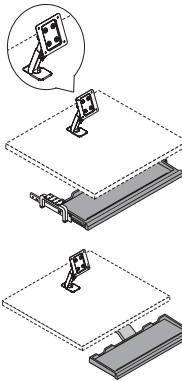

With Center Mount Articulating keyboard drawer

28"	3.1 / 15	SMA-1-0203-CK-28	\$597
30"	3.2 / 15	SMA-1-0203-CK-30	\$597
34"	3.4 / 15	SMA-1-0203-CK-34	\$597

Without keyboard drawer

	1.4 / 3	SMA-1-0203-XK	\$299
--	---------	---------------	-------

Arm for Widescreen

- Weight of widescreen cannot exceed 21 lbs.

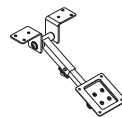

Adjustable from fully- to semi-recessed positions. Converts existing standard Nova Downview CRT monitor system to a widescreen system.

.2 / 3	FPA-8-2006	\$258
--------	------------	-------

Options

Tinted and tempered glass



Can only be ordered as replacement glass. Must provide PO number of purchased desk. Shipped separately.

18 x 18 x 1/4	.5 / 8	AC-SG10701818	\$89
21 x 18 x 1/4	.5 / 9	AC-SG10721821	\$92
21 x 21 x 1/4	.6 / 10	AC-SG10712121	\$102
24 x 21 x 1/4	.6 / 11	AC-SG10732124	\$106

Widescreen glass

16 x 21 x 1/4	.5 / 9	AC-SG10701621W	\$92
18 x 21 x 1/4	.5 / 9	AC-SG10721821W	\$92
21 x 24 x 1/4	.6 / 11	AC-SG10732124W	\$106

To order, specify:
1. Model number

The Trolley EXL / Components and Dimensions

Work surface footprint: 28 1/2" W x 8 1/2" D
Work surface cut-out: 28 1/8" W x 7 7/8" D

Min. work surface depth: 24"
Min. kneespace width: 27"

Maximum Dimensions for Flat Panel Display:
2 1/2" D x 22 7/8" W x 14 1/2" H
Fits most widescreens up to 24" diagonal

TROLLEY EXL

Low voltage electrical motor to lift and lower monitor. Display submerges into desktop when not in use. Intelligent Motion Technology™ provides operational intuition. Tamper guard security hardware. Provides vertical tilt adjustment in "up" position. Access doors automatically open and close. Secure to worksurface with supplied locking clips.

KEYBOARD DRAWER

Textured black thermoformed ABS keyboard drawer features soft radius edges. Five positive inward and outward stop locations. Outward locking tabs prevent accidental removal of keyboard drawer.

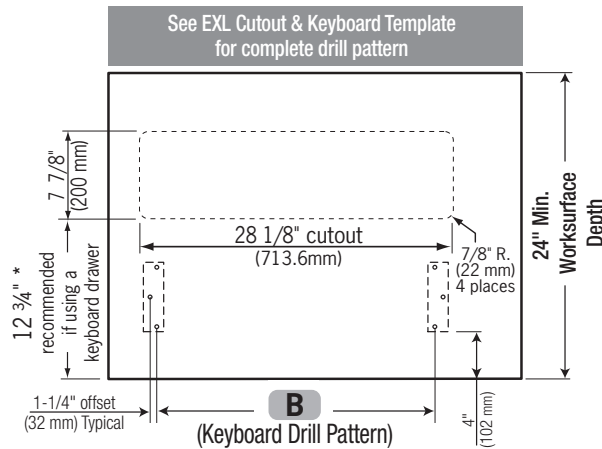
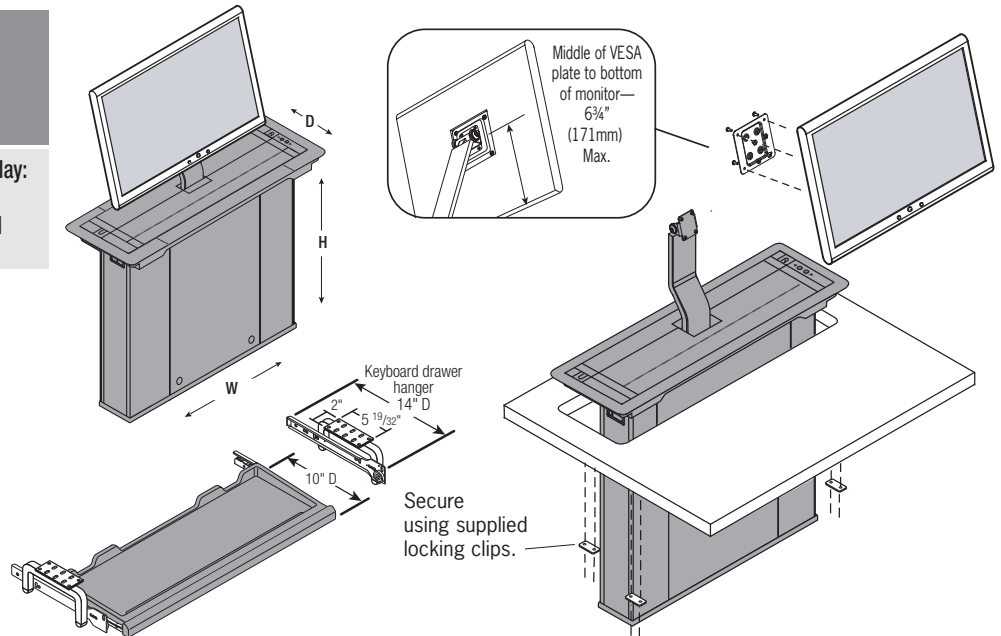

Keyboard size	Dimension A Min. Kneespace Width	Dimension B Keyboard drill pattern
27"	28 5/8" (727 mm)	25 5/16" (643 mm)
28"	29 1/2" (742 mm)	26 1/8" (663 mm)
30"	31 5/8" (799 mm)	28 1/16" (712 mm)
34"	35 1/2" (900 mm)	32 1/8" (815 mm)

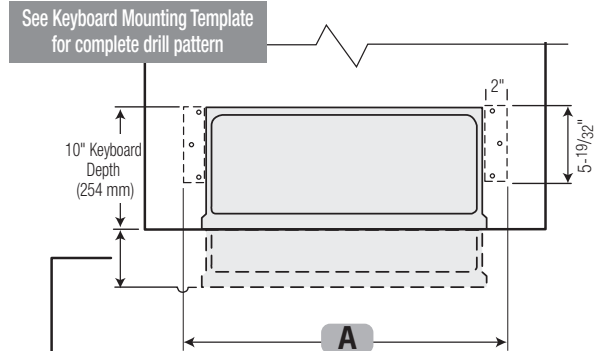

Keyboard drawer pulls out 10" (254mm) from edge of work surface. 1st stop at 7 9/16" (192mm)

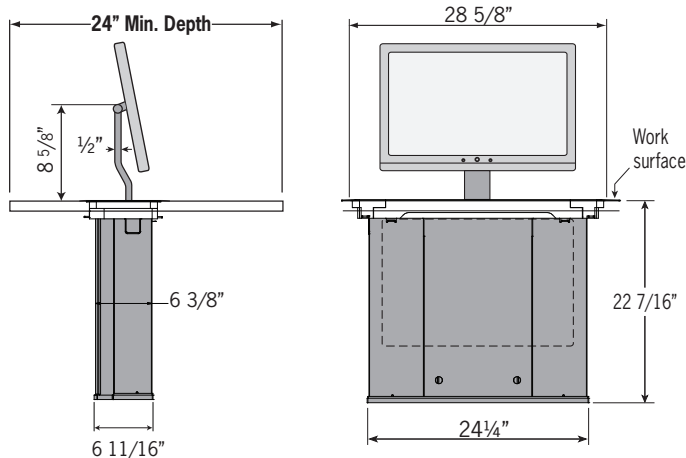

Dimensions are for underneath side of worksurface. Product specifications are subject to change without notice. Dimensions are nominal.

Retrofit

The Trolley E / Components and Dimensions

Work surface footprint: 24 1/2" W x 8 1/2" D
 Work surface cut-out: 24 3/32" W x 7 7/8" D

Min. work surface depth: 24"
 Min. kneespace width: 25"

Maximum Dimensions for Flat Panel DiOdisplay:
 2 1/2" D x 18-7/8" W x 14 1/2" H
 Fits most monitors up to 21" (diagonal)
 or 20" widescreen

TROLLEY E

Low voltage electrical motor to lift and lower monitor. Display submerges into desktop when not in use. Intelligent Motion Technology™ provides operational intuition. Tamper guard security hardware. Provides vertical tilt adjustment in "up" position. Access doors automatically open and close. Secure to work surface with supplied locking clips.

KEYBOARD DRAWER

Textured black thermoformed ABS keyboard drawer features soft radius edges. Five positive inward and outward stop locations. Outward locking tabs prevent accidental removal of keyboard drawer.

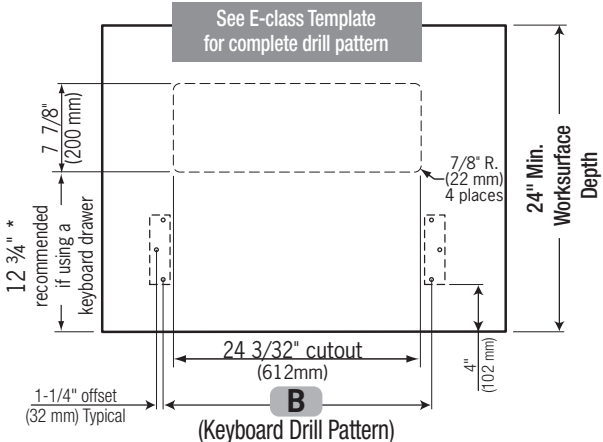
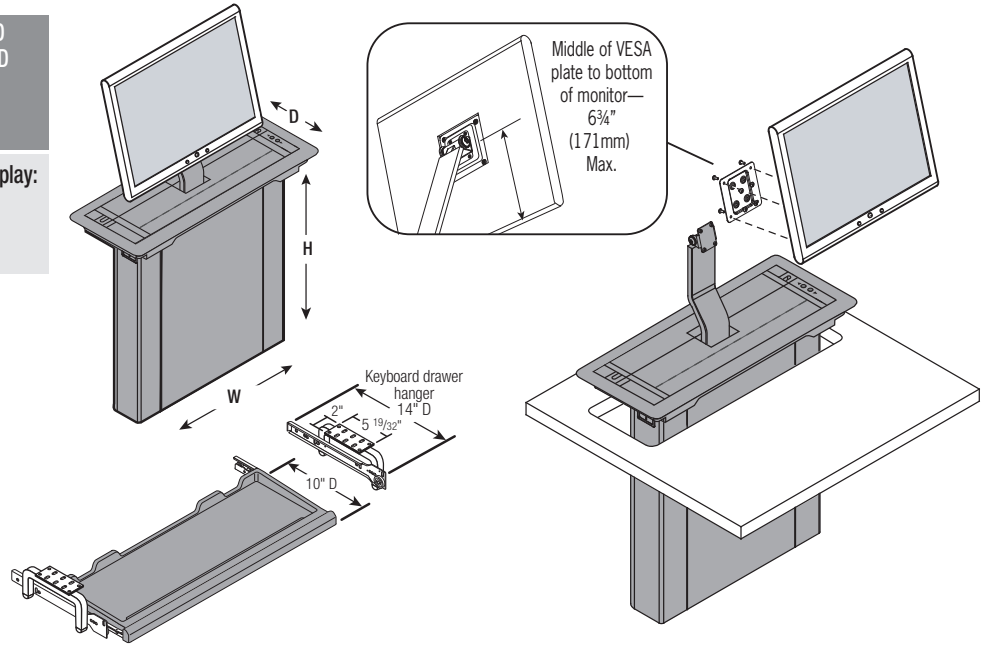

* Note: If using a 22" width keyboard tray, Trolley must be set back a minimum of 15".

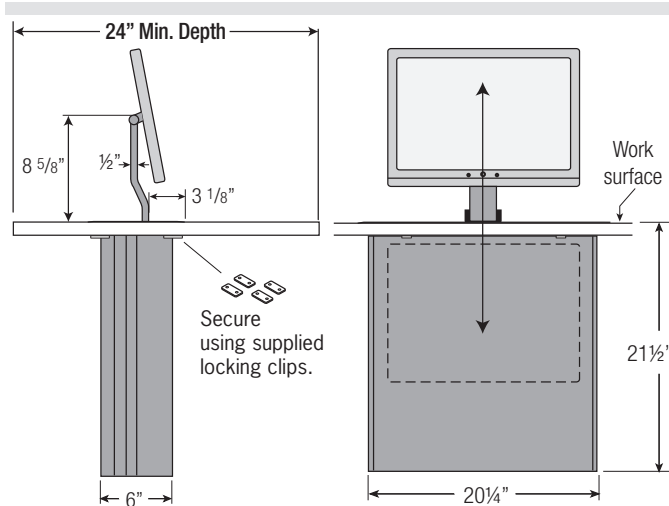

Keyboard size	Dimension A Min. Kneespace Width	Dimension B Keyboard drill pattern
22"	22" (562 mm)	18 13/16" (478 mm)
24"	25 7/8" (658 mm)	22 19/32" (574 mm)
27"	28 5/8" (727 mm)	25 5/16" (643 mm)
28"	29 1/2" (742 mm)	26 1/8" (663 mm)
30"	31 5/8" (799 mm)	28 1/16" (712 mm)
34"	35 1/2" (900 mm)	32 1/8" (815 mm)

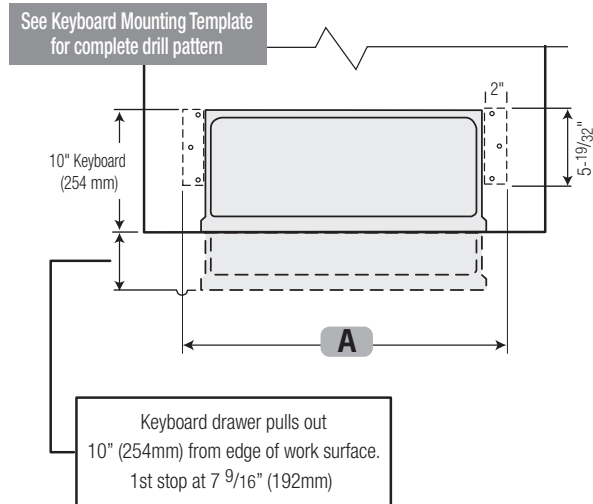

Dimensions are for underneath side of work surface. Product specifications are subject to change without notice. Dimensions are nominal.

To order, specify:
1. Model number

FPA-8-2006 Widescreen Arm / Components and Dimensions

Maximum Weight for Flat Panel Display: 21 lbs.

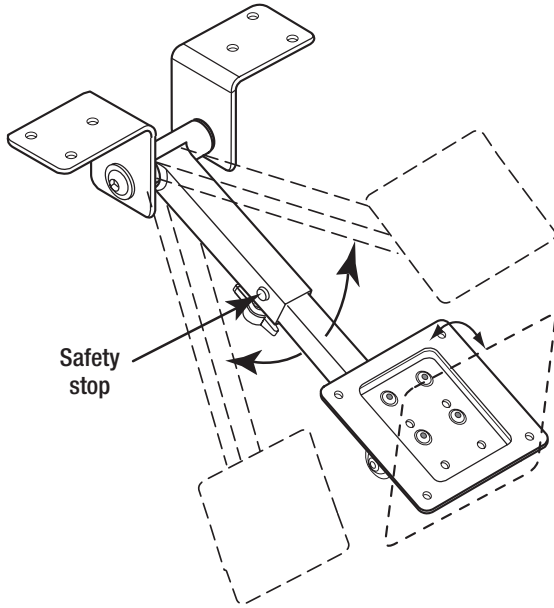

Work Surface Thickness: 1" - 2" thick work surface

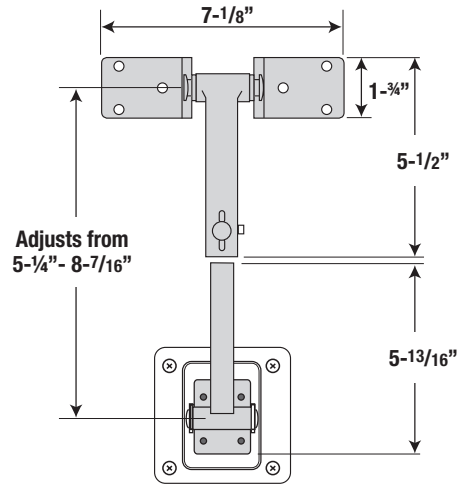
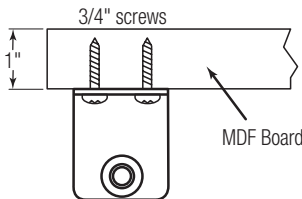
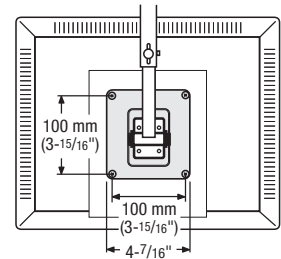
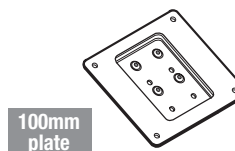
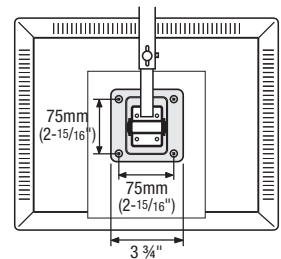

PLATE SIZES

The arm ships with a 100mm VESA plate only. The 75mm VESA plate is available as a separate line item. (See pg. 57)



WORK SURFACE SPECIFICATION DIAGRAMS

The following are meant to be used as a guide to help determine the appropriate application (fully-recessed or semi-recessed) for your flat panel display size and hole cut-out size.

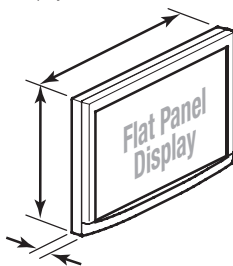

Please take into consideration the outer casing of the flat panel display when using in a semi-recessed position.

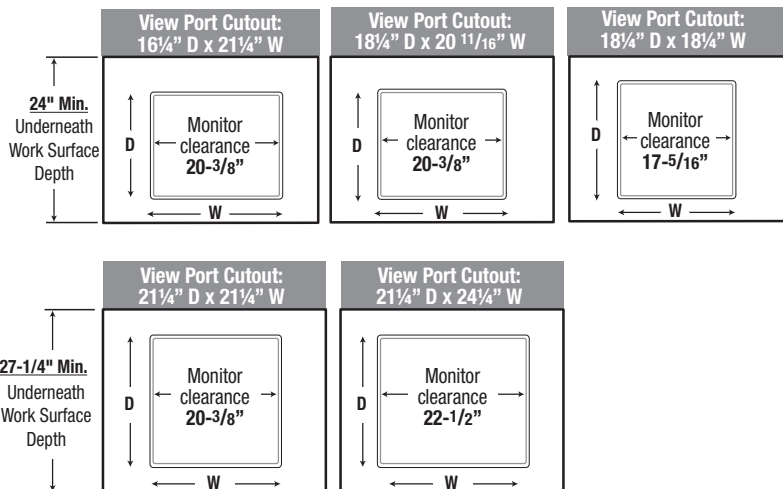

Dimensions are for underneath side of worksurface. Product specifications are subject to change without notice. Dimensions are nominal.

Retrofit

Downview™ / Components and Dimensions

Maximum weight for flat panel display: 21lbs.

Maximum Dimensions for Flat Panel Display:

- FPA-0-1621: 19½" W x 12½" H (495mm x 318mm)
- FPA-0-1818: 17" W x 14½" H (432mm x 368mm)
- FPA-0-1821: 20-1/8" W x 14½" H (511mm x 368mm)
- FPA-0-2121: 20-1/8" W x 19" H (511mm x 482mm)
- FPA-0-2124: 22-1/2" W x 19" H (572mm x 482mm)

VISOR

For unusual lighting situations or to create the optimal level of viewing comfort, each fully-recessed retrofit kit includes a textured black thermofomed ABS visor.

- 12" D x 20-3/4" W x 6" H (AC-1060)
- 12" D x 23-1/2" W x 6" H (AC-1062)
- 12" D x 26-1/2" W x 6" H (AC-1064)

GLASS

Tinted (T41 rating) and tempered with screen printed border and graphics.

- Glass for FPA-0-1621: 16" D x 21" W x ¼" H
- Glass for FPA-0-1818: 18" D x 18" W x ¼" H
- Glass for FPA-0-1821: 18" D x 21" W x ¼" H
- Glass for FPA-0-2121: 21" D x 21" W x ¼" H
- Glass for FPA-0-2124: 21" D x 24" W x ¼" H

TRIM RING

Manufactured using injection molded plastic, allowing support of view port.

- Trim ring for FPA-0-1621: 16" D x 21" W x ¼" H
- Trim ring for FPA-0-1818: 18" D x 18" W x ¼" H
- Trim ring for FPA-0-1821: 18" D x 21" W x ¼" H
- Trim ring for FPA-0-2121: 21" D x 21" W x ¼" H
- Trim ring for FPA-0-2124: 21" D x 24" W x ¼" H

FLAT PANEL ARM

Mounts underneath work surface, supporting the flat panel display on a tension-mounted steel arm. The display attaches with a VESA compliant steel plate. Can be adjusted to fit fully-recessed or semi-recessed positions.

KEYBOARD DRAWER

Textured black thermofomed ABS keyboard drawer features soft radius edges. Five positive inward and outward stop locations. Outward locking tabs prevent accidental removal of keyboard drawer.

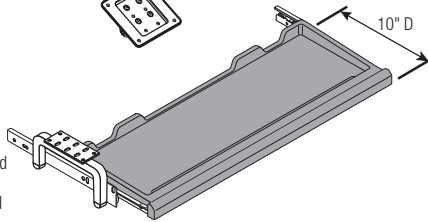
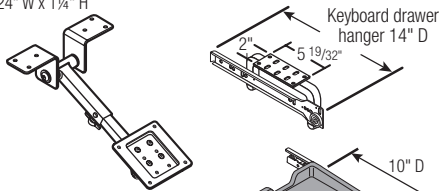
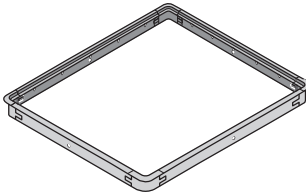
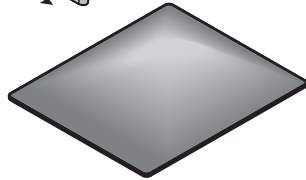
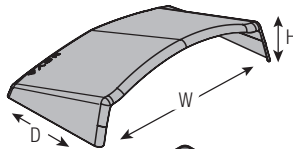

Arm with 75mm VESA plate

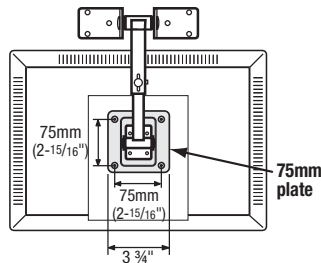

Arm with 100mm VESA plate

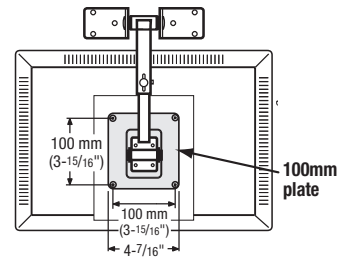

Keyboard size	Dimension A Min. Kneespace Width	Dimension B Keyboard drill pattern
22"	22" (562 mm)	18 13/16" (478 mm)
24"	25 7/8" (658 mm)	22 19/32" (574 mm)
27"	28 5/8" (727 mm)	25 5/16" (643 mm)
28"	29 1/2" (742 mm)	26 1/8" (663 mm)
30"	31 5/8" (799 mm)	28 1/16" (712 mm)
34"	35 1/2" (900 mm)	32 1/8" (815 mm)

See Keyboard Mounting Template for complete drill pattern

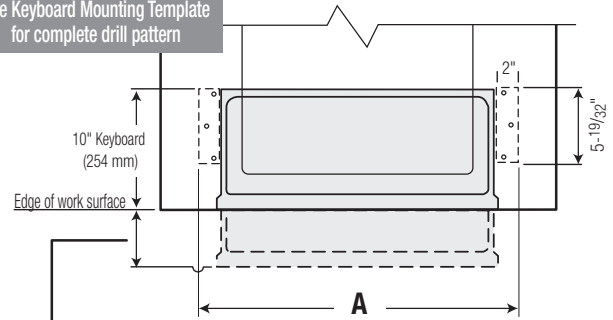

Keyboard drawer pulls out 10" (254mm) from edge of work surface.
1st stop at 7 9/16" (192mm)

Kit Model No.	Dimension C Min. Work Surface Depth	Dimension D1 x Dimension D2 View Port Cut-Out (W x D)
FPA-0-1621	24" (610 mm)	21 ¼" (540 mm) x 16¼" (413 mm)
FPA-0-1818	24" (610 mm)	18 ¼" (464 mm) x 18¼" (464 mm)
FPA-0-1821	24" (610 mm)	20 11/16" (526 mm) x 18¼" (464 mm)
FPA-0-2121	27¼" (692 mm)	21 ¼" (540 mm) x 21¼" (540 mm)
FPA-0-2124	27¼" (692 mm)	24 ¼" (616 mm) x 21¼" (540 mm)

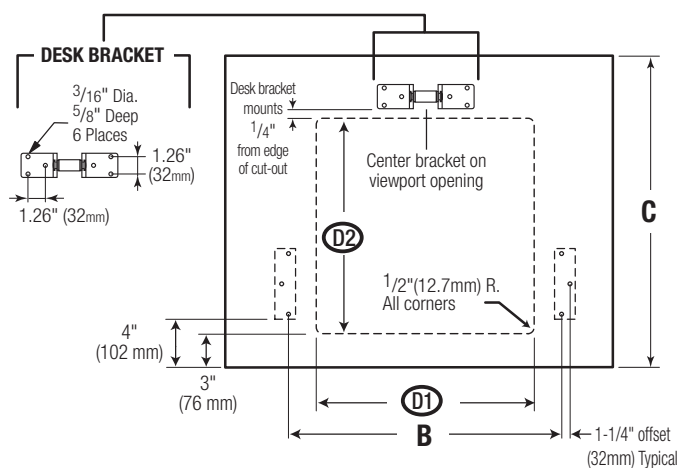
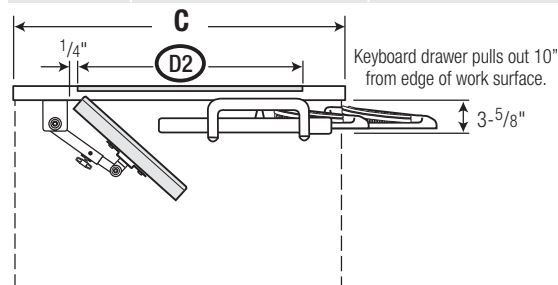

The flat panel arm ships with 100mm VESA plate only. 75mm VESA plate available as separate item (See Page 57).

Dimensions are for underneath side of work surface. Product specifications are subject to change without notice. Dimensions are nominal.

To offset your viewport and keyboard drawer, please call Customer Support at 1-800-730-6682 for special installation instructions.

To order, specify:

Surface Mount Arm / Components and Dimensions

Maximum Weight for Flat Panel Display: 21 lbs.
Maximum Dimensions for Flat Panel Display:
Up to 24" diagonal widescreen

SURFACE MOUNT FLAT PANEL ARM

Mounts underneath work surface through grommet hole, supporting the flat panel display on a steel arm. The display attaches with a VESA compliant steel plate.

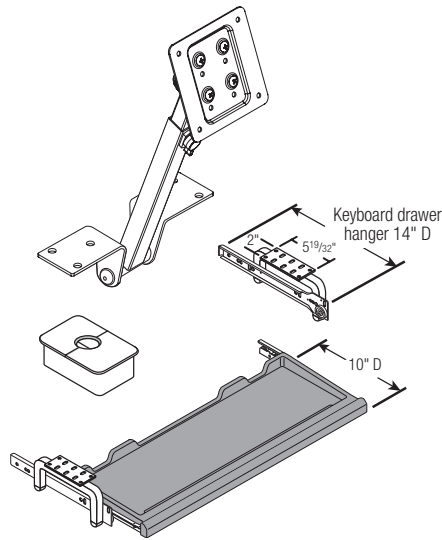

GROMMET

Black plastic work surface grommet with removable cover.

KEYBOARD DRAWER

Textured black thermoformed ABS keyboard drawer features soft radius edges. Five positive inward and outward stop locations. Outward locking tabs prevent accidental removal of keyboard drawer.

Arm with 75mm VESA plate

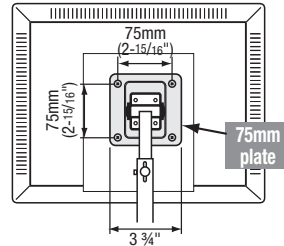

Arm with 100mm VESA plate

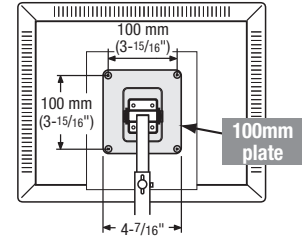

Keyboard size	Dimension A Min. Kneespace Width	Dimension B Keyboard drill pattern
22"	22" (562 mm)	18 13/16" (478 mm)
24"	25 7/8" (658 mm)	22 19/32" (574 mm)
27"	28 5/8" (727 mm)	25 5/16" (643 mm)
28"	29 1/2" (742 mm)	26 1/8" (663 mm)
30"	31 5/8" (799 mm)	28 1/16" (712 mm)
34"	35 1/2" (900 mm)	32 1/8" (815 mm)

Bracket mounted to underside of work surface.

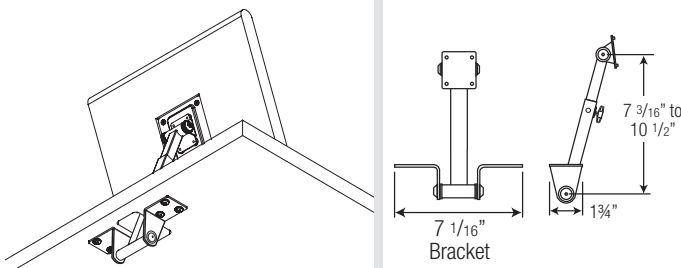

See Keyboard Mounting Template for complete drill pattern

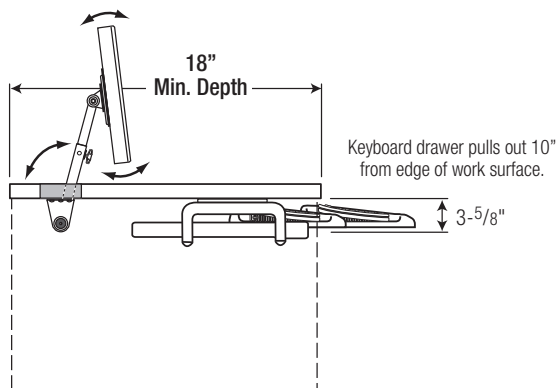
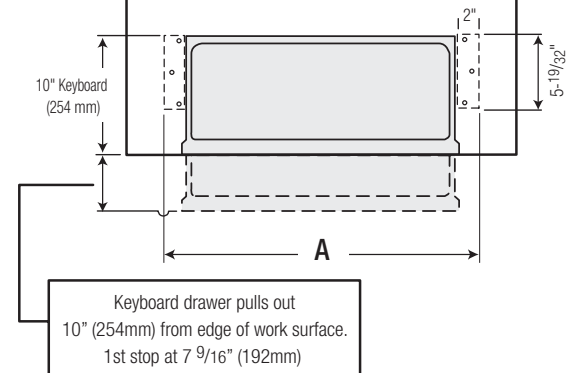

1-1/16" (27mm) for 18" or 24" D Surface
3-13/16" (96.7mm) for 30" D Surface

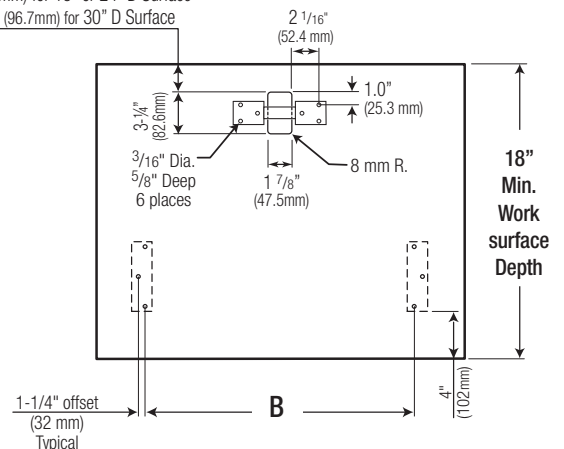

Dimensions are for underneath side of worksurface. Product specifications are subject to change without notice. Dimensions are nominal. To offset your viewport and keyboard drawer, please call Customer Support at 1-800-730-6682 for special installation instructions.

Visual Display Options

Display Option

Features, Benefits and Options

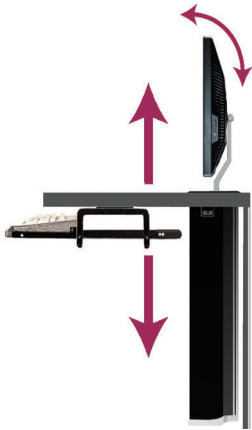

The Trolley™ Personal Monitor Arm Systems

- Available in all Series
- Low voltage electrical motor to lift and lower monitor
- Intelligent Motion Technology™ provides operational intuition
- Optional keyboard choices
- **EXL** suitable for most widescreens up to 24" diagonal
- **E** suitable for most widescreens up to 21" diagonal or 20" widescreen
- Display submerges into desktop when not in use
- Tamper-guard security hardware
- Access door automatically opens and closes
- Provides vertical tilt adjustment in "up" position
- Ideal for secure environments
- Durable metal enclosure under desktop
- Available retrofit kit

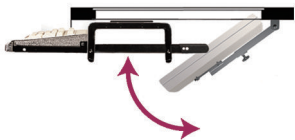

Downview™

- Available in all Series except Tables
- Monitor size varies by Visual Display Option selected
- Places display at a natural viewing angle
- Saves valuable desktop space
- Tamper-guard security hardware
- Tinted, tempered glass viewport
- Protects valuable hardware
- Available retrofit kit
- Optional keyboard choices

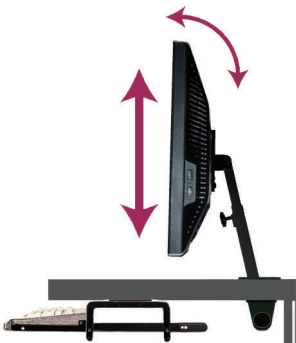

Surface Mount Arm for Widescreen

- Available in all Series
- Height and tilt adjustable
- Easily accommodates up to 24" diagonal widescreen monitor
- Provides added security and control in any environment
- Secures flat panel to desk to protect valuable hardware
- Optional keyboard choices

Dimensions & Tolerances

- Minimum work surface depth: 24"
- Minimum knee space width: **E:** 25" **EXL:** 27"
- Work surface footprint:
EXL: 28.5" W x 8.5" D
E: 24.5" W x 8.5" D
- Monitor, viewport and keyboard sizes vary by Series. For specifications, refer to Visual Display Options in each selected Series.

- Minimum work surface depth: 24"-26"
- Viewport and monitor sizes vary by Series. For specifications, refer to Visual Display Options page in each selected Series.

- Minimum work surface depth: 18"
- Monitor sizes vary by Series. For specifications, refer to Visual Display Options in each selected Series.

Keyboard Options *See next page for keyboard details and other Essential Accessories*



NOVA Keyboard Tray
Trolley E - 22" to 34" Widths
Trolley EXL - 27" to 34" Widths



Center Mount Articulating
Keyboard Mechanism
and Tray
28" to 34" Widths



NOVA Keyboard Tray
22" to 34" Widths

Center Mount Articulating
Keyboard Mechanism
and Tray is not
available with this
Visual Display Option

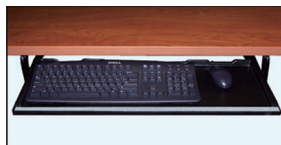

NOVA Keyboard Tray
22" to 34" Widths



Center Mount Articulating
Keyboard Mechanism
and Tray
28" to 34" Widths

Essential Accessories



Center Mount Articulating Retractable Keyboard Mechanism & Tray

Features lift and lock arm and easy guide track. Swivels, tilts, and tucks neatly under work surface. Tray is black, matte finish plastic with room for a mouse.

AC-CK102802KM 28"\$329
 AC-CK103002KM 30"\$329
 AC-CK103402KM 34"\$329



Organizer Drawer - Large

Keep small supplies organized with this handy drawer. Attaches to underside of work surface.

19" D x 23.5" W x 2.5" H

AC-ODL17243.....\$146

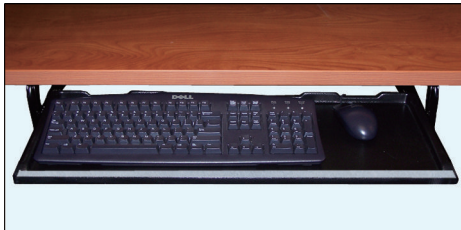

NOVA Keyboard Tray

Tucks neatly away under the work surface. Five locking positions. Tray is black, matte finish plastic.

AC-NK102022 22"W.....\$196
 AC-NK102024 24"W.....\$196
 AC-NK102027 27"W.....\$196
 AC-NK102028 28"W.....\$196
 AC-NK102030 30"W.....\$196
 AC-NK102034 34"W.....\$196



Organizer Drawer - Small

Smaller, smart design keeps office supplies within easy reach. Attaches to underside of work surface.

16.5" D x 22.5" W x 2.5" H

AC-ODS17203.....\$134



Organizer Tray

Black plastic tray fits into standard sized box drawer. Provides ample space for small office supplies. Tray can be removed or slid out of the way for access to the bottom of the drawer.

12.75" W x 6" D x 1" H

AC-OTB61.....\$32

Please Note: All items on this page must be **Field** installed.



Rectangular Wire Grommet

Black plastic grommet cover is removable for easy wire management.
 1 7/8" D x 3 1/4" W x 1 1/4" H (cutout dimensions)

If Installed (available for work surface only):
 Please provide sketch to indicate placement location
 WG1080.....\$72
If Sold Separately (not part of base model):
 AC-WG1080.....\$37

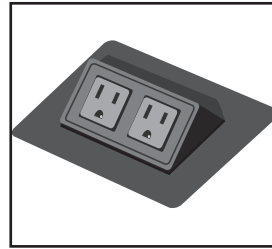

Power Center

Two grounded receptacles. 6Ft, 15 Amp cord. Made of die-cast zinc. Black powder coat finish. UL Listed.
 3 3/4"D x 5"W cutout dimensions

If Installed (available for work surface only):
 Please provide sketch to indicate placement location.
 11225PP..... \$346
If Sold Separately (not part of base model):
 AC-11225PP..... \$303



Round Wire Grommet

Black plastic grommet cover can be swiveled shut if not in use.
 2.75" Diameter x 1" H

If Installed (available for work surface only):
 Please provide sketch to indicate placement location
 RWG01.....\$85
If Sold Separately (not part of base model):
 AC-RWG01.....\$43

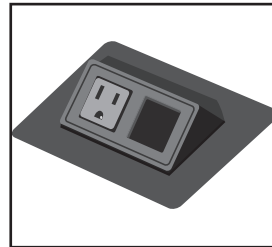

Power/Data Center

One grounded receptacle. One opening for voice/data jack. 6Ft, 15 Amp cord. Made of die-cast zinc. Black powder coat finish. Voice/Data Adapter Kit (included) provides adapters for couplers & jacks from a variety of manufacturers. UL Listed.
 3 3/4"D x 5"W cutout dimensions

If Installed (available for work surface only):
 Please provide sketch to indicate placement location.
 11225PD \$346
If Sold Separately (not part of base model):
 AC-11225PD..... \$303

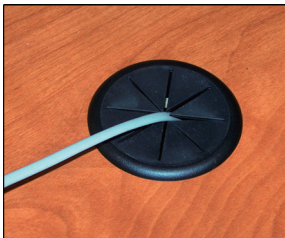

Star Cut Wire Grommet

Black plastic grommet with star cut opening allows more cords and cables to pass through.
 2.75" Diameter x 1" H

If Installed (available for work surface only):
 Please provide sketch to indicate placement location
 RWGSC.....\$85
If Sold Separately (not part of base model):
 AC-RWGSC.....\$43

Essential Accessories *(continued)*



Power Strip

Six foot power cord. Six outlets total. Switch is located on the strip. UL listed. 15A 125V 60Hz 1875W. Please verify your local codes before making electrical connections.

AC-PS1125.....\$104



Adjustable CPU Holder

Mounts to underside of work surface. Fits most CPUs up to 18" H. Width adjusts to fit CPUs from 4.25" to 7.5" W.

AC-ACPU1.....\$196



Wire Management

Black plastic self-adhesive wire channel keeps all cords and cables under control. Position wherever cable management is needed.

98.5" x 1.5" x 1.5"

AC-WM68.....\$69



Task Light & Connector Cord

16 Watt, T4 fluorescent bulb produces warm, 3000K, white light. Ten foot power cord.

3 5/16" D x 19 1/2" W x 1 7/8" H

AC-TL1220BLACK.....\$142

Connector cord

AC-FC891 (12" long).....\$12

AC-FC892 (24" long).....\$13

AC-FC893 (48" long).....\$16



USB Port Extension

Features one USB port with living hinged cover. Fits into designated opening on top of Trolley E housing. Six foot cord plugs into USB port in CPU.

2.5" x 1" x 1"

AC-USB01.....\$62

Please Note: All items on this page and next page are **Field** installed.

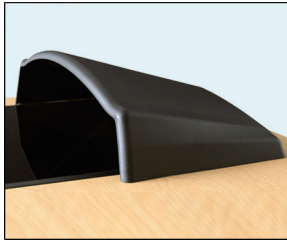

Visor

Black plastic visor can be used with NOVA's downview technology when unusual lighting conditions are present.

- 12" D x 23-1/2" W x 6" H (for 21" W Viewport)
AC-1062.....\$81
- 12"D x 26-1/2"W x 6" H (for 24" W Viewport)
AC-1064.....\$90

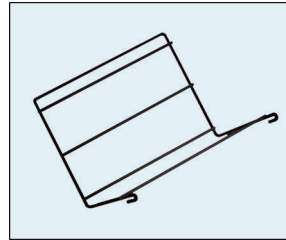

Flat Panel Adapter

Allows NOVA CRT desks to accommodate wide-screens and still use NOVA's downview technology.

- For 18" x 18" or 18" x 21" viewports
AC-FA4018\$43
- For 21" x 21" viewports
AC-FA4021\$43



Tackboards

NOVA tackboards come in a variety of colors and sizes to fit under any size hutch we offer.

See the end of each product section for specific sizes.

See the inside back cover of this catalog for fabric color selections.



Extended VESA Plate Adapter

For widescreens with off-center VESA mount locations, an Extended VESA Plate Adapter is required for use with NOVA Visual Display Options

3 3/4" W x 6 1/8" H

- AC-VESA\$44

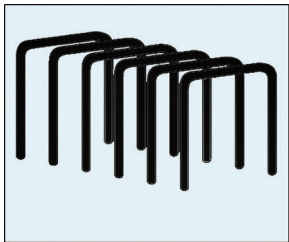

Wire Hutch Dividers

Keep things organized with these wire dividers designed for your overhead storage hutch. Set of six. Note: Hutches come with one set of dividers included.

Wire hutch dividers for Office Solutions only.

- AC-1100.....\$56

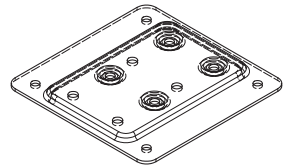

75mm VESA Plate

For monitors with 75mm VESA plates, required for use with NOVA Visual Display Options

3" W x 3" H

- AC-VESA75\$22

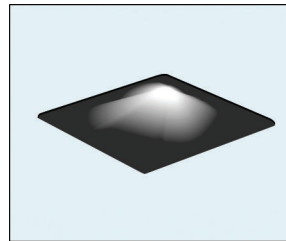

Replacement Viewport Glass

For furniture that incorporates the Downview Visual Display Option — replacement viewport glass.

- AC-SG10701818 (18"D x 18"W)\$89
- AC-SG10721821 (21"D x 18"W)\$92
- AC-SG10712121 (21"D x 21"W)\$102
- AC-SG10732124 (24"D x 21"W)\$106

Tinted and tempered glass

Widescreen glass

- AC-SG10701621W (16"D x 21"W)\$92
- AC-SG10721821W (18"D x 21"W)\$92
- AC-SG10732124W (21"D x 24"W)\$106

**For series specific accessories,
please refer to the back of each product section**

Sample Purchase Order

Customer Information

Customer Name
 Address
 City, State, Zip
 Phone #
 Fax #
 E-mail Address

Purchase Order # _____

Date Issued: _____

Vendor Information

NOVA Solutions, Inc.
 P.O. Box 725
 Effingham, IL, USA 62401

Ship To:

Name (your point of destination)
 Address (your point of destination)
 City, State, Zip
 Phone #
 Delivery Contact Name

	Model Numbers	Description	Qty	List Price	Ext. List Price
Line 1: Base Model Number:	66-LS304841LM	Lectern, 30"D x 48"W x 41"H Laminate modesty, three front doors	1	\$3,679	\$3,679
<i>Subset of Line 1*</i>	Color:	174 030 <i>Black/Graphite Nebula (Base & Work Surface)</i>			
	Drawer or Door Pull Style/Finish:	SM <i>Steel pull / Chrome Matt finish</i>			
	Visual Display: Accessories:	FPA1821NK RWGO1 <i>Downview-Flat panel display 18"D x 21"W Round wire grommet (Specify location on worksurface)</i>	1	\$ 438	\$ 438
			1	\$ 85	\$ 85
		<i>Subtotal (line 1)</i>		\$ 4,202	\$4,202
Line 2: Base Model Number:	66-SH222201L	Flip-up Shelf, Left (Field Installed)	1	\$ 511	\$ 511
		Subtotal (all lines)			\$4,713
		Handling Fee**			\$ 100
		Grand Total			\$4,813

Please add any taggings:

Example: Computer classroom #104

Please add point of contact, phone number and e-mail address:

Example: Debbie Smith, 800-555-5678, dsmith@domainname.com

Please add any shipping or special instructions:

Example: Please call Doug at 555-687-5309, 24 hours before delivery

Example: Must have delivery by 12/31

Laminate Selections

B = Base Color
W = Work Surface Color

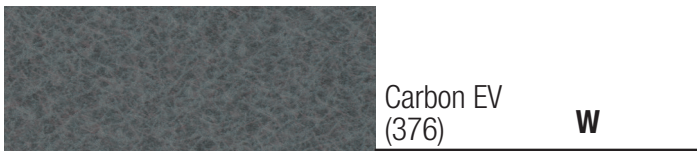
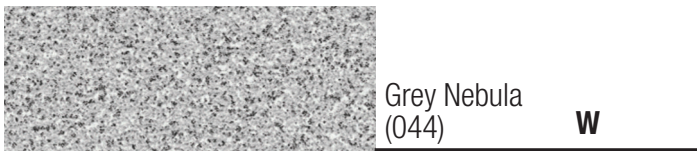
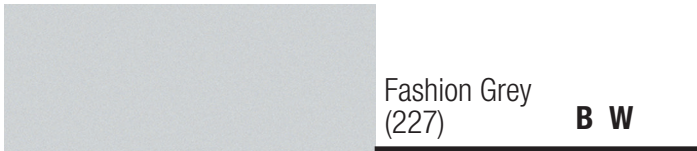
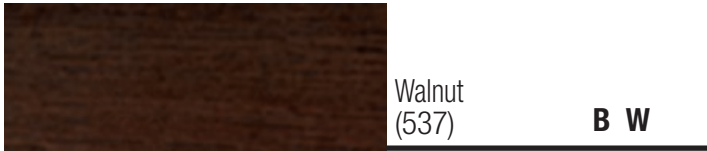
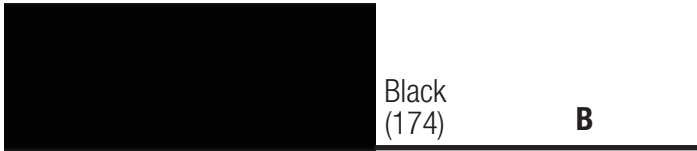

Colors are subject to variations in printing. For exact color matching, please request a laminate chip sample by calling customer support at 1-800-730-6682 or your local sales representative.

Matching Metal Colors



Polished Black
(PBL)

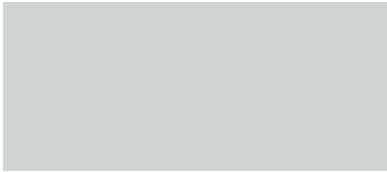

Polished Silver
(PSL)



Slate
(SLL)

Colors are subject to variations in printing. For exact color matching, please request a metal chip sample by calling customer support at 1-800-730-6682 or your local sales representative.

Company Overview

It all began when John Lechman, cofounder of a kitchen cabinet company in Denver, Colorado, discovered a unique computer desk concept at an office furniture trade show in Chicago, IL. All of the computer hardware was contained beneath the work surface with the monitor positioned at an angle beneath the desktop.

Mr. Lechman secured the rights to produce the product in wood and laminate— purchasing the parts and materials from an Effingham, Illinois-based company. Production began on the new line of wood computer furniture in Denver, Colorado in 1988. He then began selling the product to corporate offices across the United States and Canada. Soon after, users began to report experiencing less neck and eye discomfort after using the new desk technology. The “Downward Gaze”™ angle was, in fact, a viable, ergonomic solution that helped to alleviate many of the physical problems experienced by computer users.

In 1990, John Lechman moved the operation to Effingham, Illinois. In 1995 the company changed its name from Nova Office Furniture to Nova Solutions, Inc. The new name better reflected the company's quest to provide furniture solutions for computer users in a variety of market segments.

In 2003, Mr. Lechman began the daunting task of developing a solution for flat panel displays. The goal was to find an innovative solution for computer users who preferred to view their monitor in the traditional, straightforward position, while maximizing desktop work space and providing a level of security and privacy. After years of testing, field research, and several prototypes, The Trolley™ was born. The Trolley™ is a Personal Monitor Arm System that raises and lowers a flat panel display from beneath the desktop on demand. The Trolley™ gets its name from the inner workings of the mechanism. The display mounts to an arm that moves up and down on a track much like a trolley car.

Today, Nova Solutions, Inc., remains one of the industry's fastest growing and most innovative manufacturers of unique computer desks and high quality office furniture.

Although integrating technology via the *Downview* or *The Trolley™* remains an important part of Nova's success, the company has grown to be much more than just a computer workstation company. Nova provides a comprehensive array of laminate furniture that allows users to make the most of available work space.

From reception areas and training rooms to mid-management and executive offices, Nova provides complete solutions for a variety of work environments. Our “solutions” and accessories are used in virtually every electronic environment imaginable, including offices, call centers, banks, hotels, medical facilities, airports, training companies, classrooms, kitchens, homes, and many other locations.

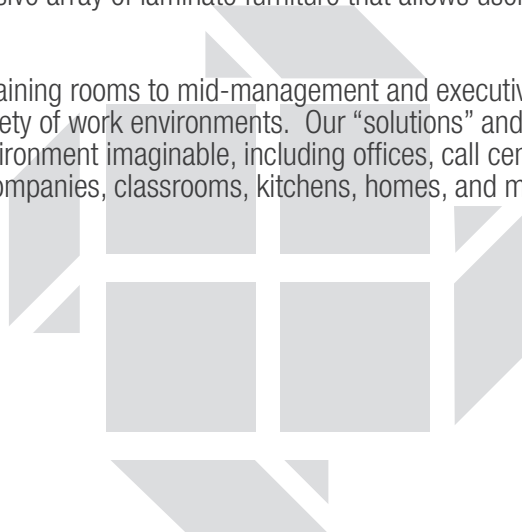



NOVA[®]

The Right Solutions

421 W. Industrial Avenue
Effingham, IL 62401
Phone: 800-730-6682
Fax: 800-940-6682
www.novadesk.com



© 2015, NOVA Solutions, Inc.
Reorder #: CT006.1
Version Date: April 2016
NOVA Solutions products are protected by various
U.S. and foreign patents issued and/or pending.

2015 Catalog

